

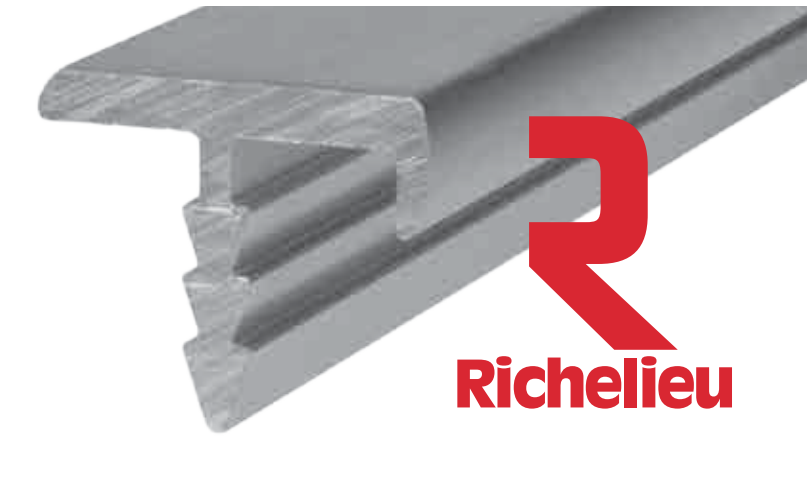

# ALUMINUM MOLDINGS & EXTRUSIONS



**Richelieu**

# FUNCTIONAL MOLDINGS

## FLAT BAR

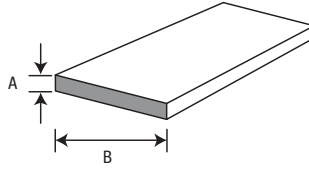
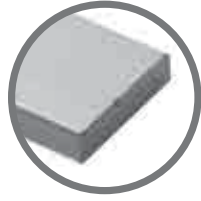

A	B	LENGTH	SATIN	MILL FINISH	BRITE CLEAR	BLACK
1/16"	1 1/4"	12'		<b>MRB602M</b>		
	2"			<b>MRB604M</b>		
1/8"	3/8"	12'	<b>24101210</b>			
	1/2"	8'	<b>71280810</b>		<b>7128140</b>	
		12'	<b>71281210</b>	<b>MRB59918M</b>		<b>71281290</b>
	3/4"	8'	<b>D0126910810</b>			
		12'	<b>D012691</b>	<b>MRB60018M</b>	<b>D01269112140</b>	
	1"	8'	<b>D0126930810</b>			
		12'	<b>D012693</b>	<b>MRB60118M</b>	<b>D01269312140</b>	
	1 1/4"	12'		<b>MRB60218M</b>		
	1 1/2"	8'	<b>D0126420810</b>			
		12'	<b>D012642</b>	<b>MRB60318M</b>	<b>D01264212140</b>	
	2"	12'		<b>D24201210</b>		
	3"	12'	<b>D24261210</b>	<b>MRB61118M</b>		
4"	12'	<b>D24281210</b>				
3/32"	1/2"	11 1/2"	<b>712829410</b>			
		14 1/2"	<b>712837010</b>			
1/4"	1"	12'		<b>MRB60114M</b>		
1/2"	1/2"	12'	<b>24081210</b>			



## 90° ANGLE UNEQUAL SIDES

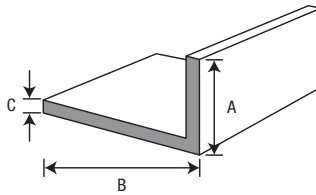
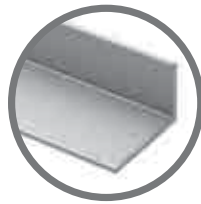

A	B	C	LENGTH	SATIN	BRITE CLEAR	STAINLESS STEEL
1/2"	3/4"	3/32"	8'	<b>D0100550810</b>		
			12'	<b>D010055</b>	<b>D010054</b>	
	1"	1/16"	8'	<b>D014110810</b>		
			12'	<b>D014111210</b>	<b>D0141112140</b>	<b>D0141112170</b>
3/4"	1 1/2"	1/8"	8'	<b>D014350810</b>		
			12'	<b>D014351210</b>	<b>D0143512140</b>	<b>D0143512170</b>



# FUNCTIONAL MOLDINGS

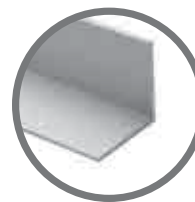
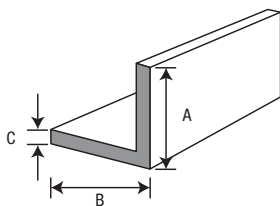

90° ANGLE  
EQUAL SIDES

A	B	C	LENGTH	SATIN	BRUSHED	MILL FINISH	BRITE CLEAR	BLACK	GOLD
1/2"	1/2"	1/16"	8'	<b>D0100570810</b>					
			12'	<b>D010057</b>		<b>MRB269M</b>			
		3/32"	12'				<b>D010063</b>		
		1/8"	12'		<b>MRB26918S</b>	<b>MRB26918M</b>			
3/4"	3/4"	1/16"	12'	<b>D010065</b>	<b>MRB369S</b>	<b>MRB369M</b>	<b>D010071</b>		<b>D010069</b>
			8'	<b>D0100650810</b>			<b>D01007108140</b>		
		3/32"	12'					<b>D010064</b>	
			1/8"	12'	<b>12321210</b>		<b>MRB449M</b>		
1"	1"	3/64"	12'	<b>12141210</b>					
			8'	<b>D0100720810</b>			<b>D01007608140</b>		
		1/16"	12'	<b>D010072</b>	<b>MRB469S</b>	<b>MRB469M</b>	<b>D010076</b>		<b>D010074</b>
			8'	<b>D0127130810</b>					
1/8"	12'	<b>D01271312</b>	<b>MRB749S</b>	<b>MRB749M</b>					
	12'								
1 1/8"	1 1/8"	1/16"	12'	<b>12161210</b>					
1 1/4"	1 1/4"	1/8"	12'		<b>MRB5569S</b>	<b>MRB5569M</b>			
1 1/2"	1 1/2"	1/16"	12'	<b>MRB1569VC</b>		<b>MRB1569M</b>			
			8'	<b>D0110730810</b>					
		1/8"	12'	<b>D011073</b>	<b>MRB156918S</b>	<b>MRB156918M</b>	<b>D011072</b>		
12'									
2"	2"	1/16"	12'	<b>MRB4469VC</b>					
		1/8"	12'	<b>MRB8469VC</b>		<b>MRB8469M</b>			
3"	3"	1/8"	12'			<b>MRBNYM613M</b>			

# FUNCTIONAL MOLDINGS

U-SHAPE

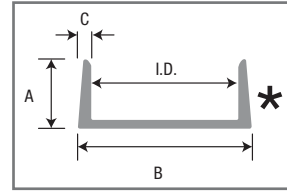
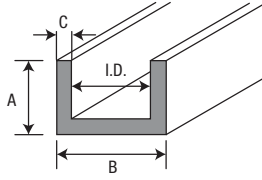
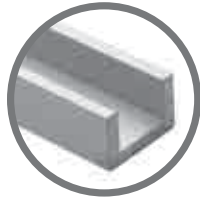

I.D.	A	B	C	LENGTH	SATIN	BRUSHED	MILL FINISH	BRITE CLEAR	BLACK	GOLD	STAINLESS STEEL
1/8"	19/64"	7/32"	3/64"	12'		<b>MRB757S</b>					
1/4"	3/8"	13/32"	1/16"	8'	<b>D0100790810</b>						<b>D01007808170</b>
				12'	<b>D010079</b>	<b>MRB257S</b>		<b>D010078</b>		<b>D010077</b>	<b>010078170</b>
5/16"	3/8"	1/2"	3/32"	12'		<b>MRB148S</b>	<b>MRB148M</b>				
3/8"	1/2"	1/2"	1/16"	8'	<b>16140810</b>						
				12'	<b>1614010</b>			<b>1614140</b>			
	5/16"						<b>MRB57M</b>				
7/16"	3/4"	9/16"	1/16"	8'	<b>D0121810810</b>						<b>D01218208170</b>
				12'	<b>D012181</b>			<b>D012182</b>	<b>D012184</b>	<b>D012183</b>	<b>012182170</b>
	9/16"					<b>MRB547S</b>					
1/2"	1/2"	3/4"	1/8"	12'	<b>D016411210</b>			<b>D0164112140</b>			
	9/16"				<b>MRB847S</b>						
	5/8"	5/8"	1/16"	8'	<b>D0100820810</b>			<b>D01008108140</b>			
				12'	<b>D010082</b>			<b>D010081</b>			
	3/4"	3/4"	1/8"				<b>MRBNYM143M</b>				
1"	5/8"	1/16"	8'	<b>D0100580810</b>							
				12'	<b>D010058</b>			<b>D010066</b>			
9/16"	3/4"	3/4"	3/32"	8'	<b>D016330810</b>						
				12'	<b>D016331210</b>			<b>D0163312140</b>			
5/8"	5/8"	3/4"	1/16"	8'	<b>D016170810</b>						
	11/32"			12'	<b>D016171210</b>			<b>D0161712140</b>			
				3/4"		<b>31981210*</b>					<b>319812170*</b>
						<b>MRBNYM134M</b>					
3/4"	11/32"	7/8"	1/16"	12'	<b>31971210*</b>						<b>319712170*</b>
	1/2"	27/32"					<b>MRB447M</b>				
		1"	1/8"		<b>D016381210</b>	<b>MRB247S</b>		<b>D0163812140</b>			
	5/8"	7/8"	1/16"	8'	<b>D0100850810</b>						
	12'			<b>D010085</b>			<b>MRB947M</b>		<b>D010084</b>	<b>D010083</b>	
3/4"	1"	1/8"		<b>MRBNYM109VC</b>	<b>MRBNYM109S</b>	<b>MRBNYM109M</b>					
7/8"	1/2"	1"	1/16"	12'			<b>MRBNYM148M</b>				
1"	13/16"	1 1/8"	1/16"	12'	<b>MRB448VC</b>	<b>MRB448S</b>	<b>MRB448M</b>				
1 1/4"	1"	1 1/2"	1/8"	8'							<b>D016440810</b>
				12'	<b>D016441210</b>			<b>D0164412140</b>			
1 1/2"	1"	1 3/4"	1/8"	16'			<b>MRBNYM734M16</b>				

\* Refer to upper right technical drawing

# FUNCTIONAL MOLDINGS

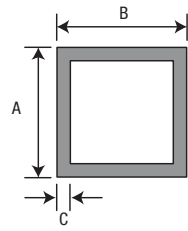

SQUARE  
TUBE



A	B	C	LENGTH	SATIN	MILL FINISH	BRITE CLEAR
1/2"	1/2"	1/16"	12'	<b>D0126941210</b>		
3/4"	3/4"	1/16"		<b>D032121210</b>		<b>D0321212140</b>
1"	1"			<b>D0126951210</b>	<b>MRBX213M</b>	<b>D01269512140</b>
1 1/2"	1 1/2"			<b>D032161210</b>		<b>D0321612140</b>
2"	2"	1/8"		<b>D0126391210</b>		<b>D01263912140</b>

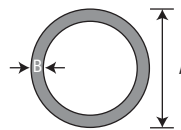
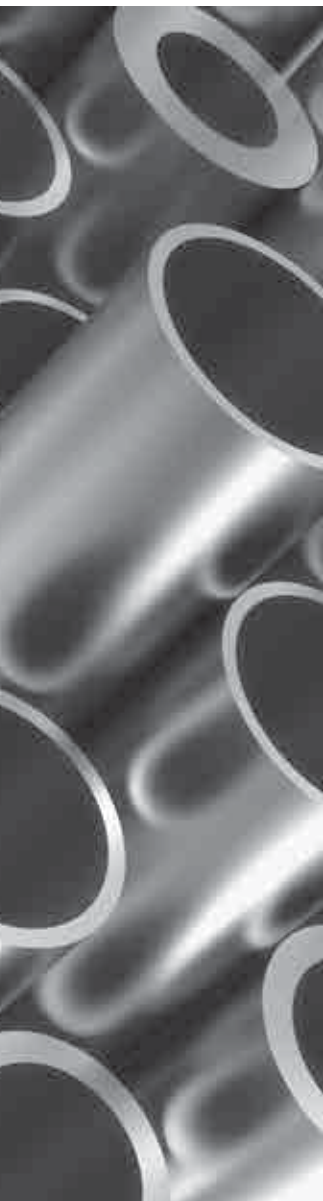

ROUND  
TUBE

A	B	LENGTH	SATIN	BRITE CLEAR
1/2"	1/16"	12'	<b>D030121210</b>	<b>D0301212140</b>
3/4"			<b>D030161210</b>	
1"			<b>D030301210</b>	<b>D0303012140</b>
1 5/16"	1/8"	8'	<b>01050810</b>	

A	LENGTH	SATIN	WHITE	EURO WHITE	GRAY	STAINLESS STEEL
7/16"	3' 7"	<b>ZRG1000U10</b>	<b>ZRG10030</b>	<b>ZRG1000U34</b>	<b>ZRG1000106</b>	<b>ZRG1000170</b>
	10'	<b>ZRG3048U10</b>		<b>ZRG3048U34</b>	<b>ZRG3048106</b>	

A	LENGTH	SATIN
1/4"	12'	<b>28101210</b>
3/8"		<b>28121210</b>
1/2"		<b>28141210</b>

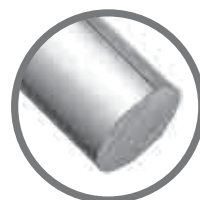
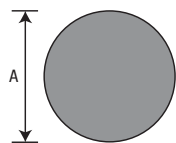

ROD

# FUNCTIONAL MOLDINGS

## Z-SHAPED PANEL CLIP

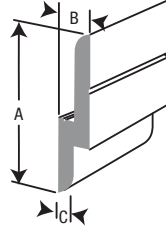
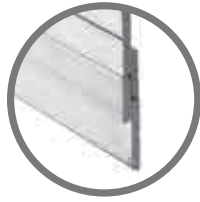

	A	B	C	PERFORATED	LENGTH	MILL FINISH
	1 3/8"	1/4"	1/8"	No	8'	<b>318708D10</b>
					12'	<b>318712D10</b>
	1 25/32"	3/16"	3/32"	Yes	2 1/2"	<b>5075070</b>
					10'	<b>5075080</b>
				No	10'	<b>MRBNYM111M</b>



## LABELLING

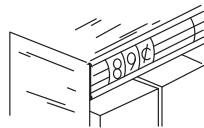
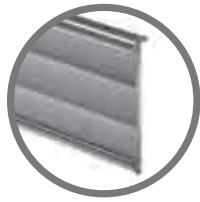

	A	B	LENGTH	FINISH
	1 1/4"	5/16"	12'	POLISHED <b>MRB618P</b>
	1 3/8"	1/4"		POLISHED <b>MRBA154PH</b>
	1 3/8"			SATIN <b>MRBA154SH</b>

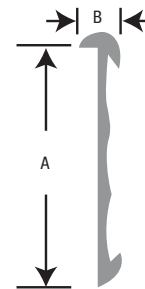

## COMMERCIAL DOOR THRESHOLD

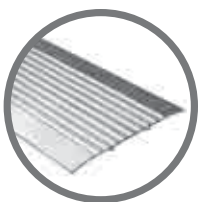

	WIDTH	HEIGHT	LENGTH	MILL FINISH
	4"	1/4"	12'-1"	<b>D0582412D10</b>
	5"			<b>D0582512D10</b>
	6"			<b>D0582612D10</b>
	4"	1/2"		<b>D0583412D10</b>
	5"			<b>D0583512D10</b>
	6"			<b>D0583612D10</b>



## LIGHT DUTY

LENGTH	MILL FINISH
8'	<b>19508D10</b>

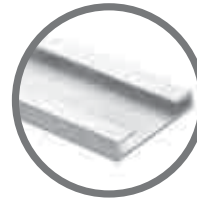
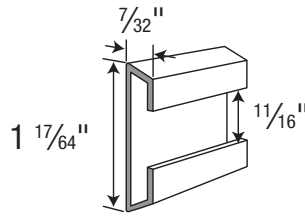

SLOT WALL  
INSERT

## MEDIUM DUTY

LENGTH	MILL FINISH
8'	<b>MRBNYM710M8</b>

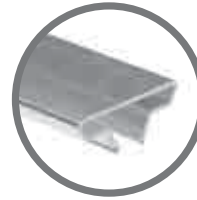
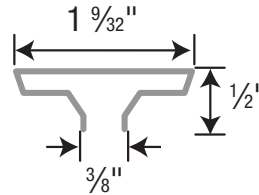

## MEDIUM DUTY

LENGTH	MILL FINISH
8'	<b>20608D10</b>

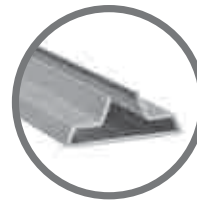
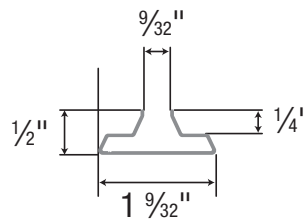

## HEAVY DUTY

LENGTH	MILL FINISH
8'	<b>N960010</b>

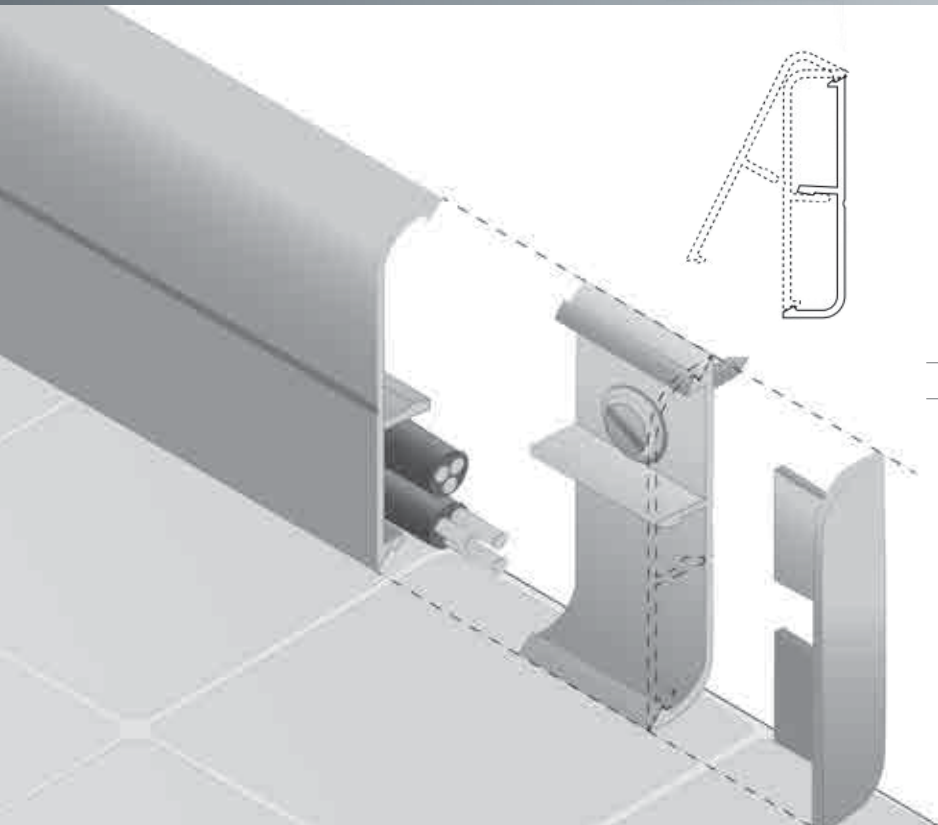
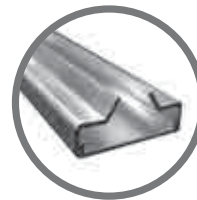
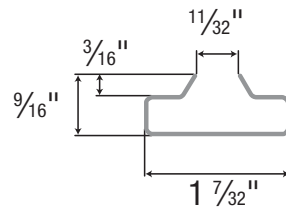

ALUMINUM  
CABLE  
MANAGER

WIDTH	HEIGHT	LENGTH	SATIN
19/32"	2 5/8"	6' 6"	<b>7007628210</b>

END CAP FOR  
CABLE  
MANAGER

SATIN  
**700762810**

# FUNCTIONAL MOLDINGS

## L-SHAPE

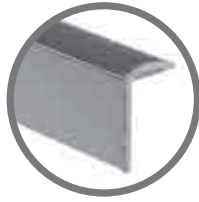

A	B	LENGTH	POLISHED	MILL FINISH	BRITE CLEAR
5/8"	1/4"	12'			<b>MRBY968BCH</b>
7/8"			<b>MRB128PH</b>		
1 1/4"				<b>MRB328MH</b>	
13/16"	1/2"				<b>MRB669BCH</b>

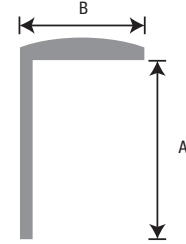

## H-SHAPE

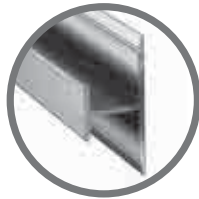

A	B	C	D	E	LENGTH	SATIN
7/8"	1 1/2"	1/16"	3/4"	5/8"	12'	<b>31311210</b>

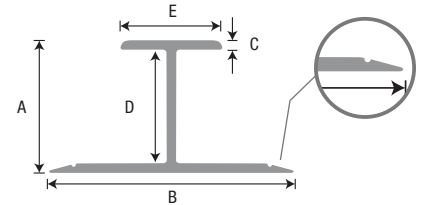

## F-SHAPE

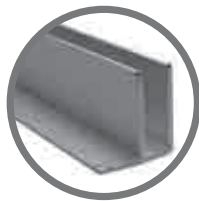

A	B	C	D	LENGTH	SATIN
1"	15/16"	1/16"	5/16"	12'	<b>71301210</b>

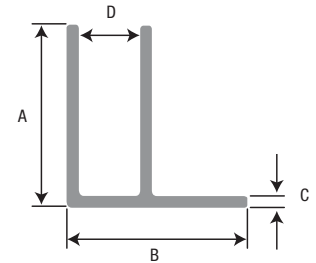

## T-ROD

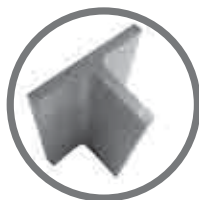

A	B	C	LENGTH	SATIN
3/4"	3/4"	1/8"	12'	<b>18301210</b>

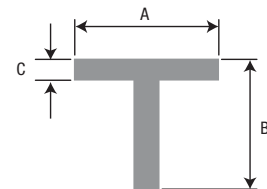



# FUNCTIONAL MOLDINGS

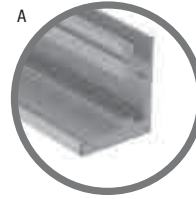
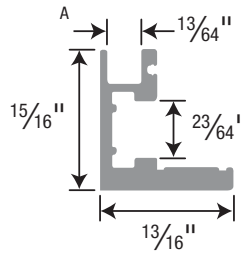

DOOR FRAME

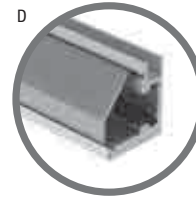
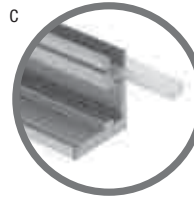
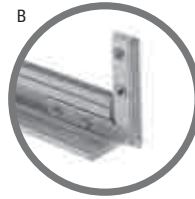

	WIDTH	HEIGHT	LENGTH	PRODUCT	FINISH
A DOOR FRAME	15/16"	13/16"	12'	<b>35041210</b>	SATIN
B 4-HOLE CONNECTING JOINT	13/32"	1 3/4"		<b>513174</b>	SATIN
C GLASS DOOR GASKET	5/32"		96"	<b>1001211</b>	CLEAR
D GLASS MOLDING	3/4"		12'	<b>10034100</b>	SILVER

LENGTH	SATIN
12'	<b>MRBNYM120VC</b>

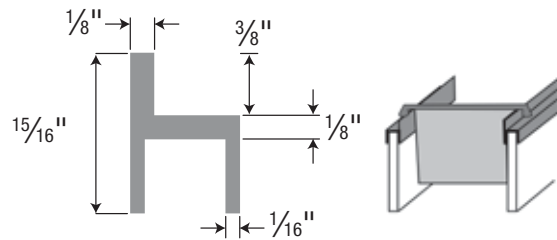

HANGING FILE SUPPORT

A	B	C	LENGTH	SATIN
3/8"	3/4"	1/16"	12'	<b>MRB141VCH</b>

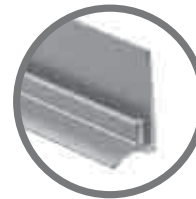
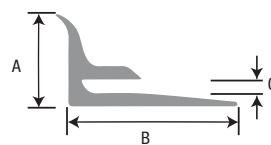

CORNER

A	B	C	LENGTH	POLISHED
7/16"	5/8"	1/16"	12'	<b>MRB252P</b>

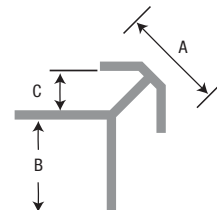

# MIRROR FINISHING MOLDINGS

## L-SHAPE

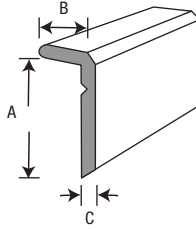

A	B	C	LENGTH	SATIN	BRITE CLEAR	GOLD	STAINLESS STEEL
5/8"	1/4"	1/16"	8'		<b>D010049</b>		
			12'	<b>D01005010</b>	<b>D010050</b>	<b>D010048</b>	<b>010048170</b>

## H-SHAPE

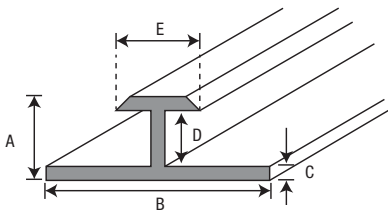
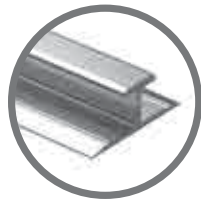

A	B	C	D	E	LENGTH	BRITE CLEAR
13/32"	1"	1/16"	9/32"	3/8"	8'	<b>D010026</b>
	1 1/4"			1/2"	12'	<b>MRB850P</b>



# MIRROR FINISHING MOLDINGS

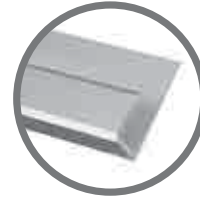
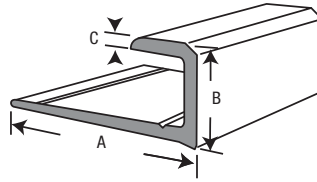

J-SHAPE

## TOP

A	B	C	LENGTH	SATIN	BLACK	BRUSHED	MILL FINISH	BRITE CLEAR	BRONZE	POLISHED	GOLD	STAINLESS STEEL
1"	7/16"	1/16"	8'					<b>D010040</b>				
			12'	<b>D01004110</b>	<b>D010035</b>			<b>D010041</b>	<b>D010037</b>			<b>D010039</b>

## BOTTOM

13/16"	7/16"	1/16"	8'					<b>D010032</b>				
			12'	<b>D01003310</b>	<b>D010027</b>			<b>D010033</b>	<b>D010029</b>			<b>D010031</b>

## OTHER

3/4"	13/64"	-	12'	<b>MRB251VCH</b>						<b>MRB251PH</b>			
7/8"	1/4"	-		<b>MRB551VCH</b>									
	3/8"	-									<b>MRB851PH</b>		
1"	5/8"	-				<b>MRB1851S</b>	<b>MRB1851M</b>			<b>MRB1851P</b>			

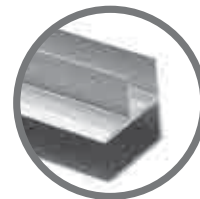
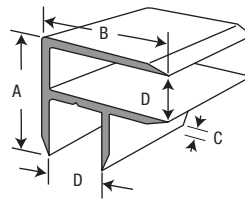

90° CORNER MOLDING

A	B	C	D	LENGTH	SATIN	BRITE CLEAR
3/4"	3/4"	1/16"	11/32"	12'	<b>D051401210</b>	<b>D0514012140</b>



Images and dimensions are provided for reference purpose only. Actual product may vary from picture shown. Please visit our website for complete information.

# FINISHING MOLDINGS

## T-SHAPE

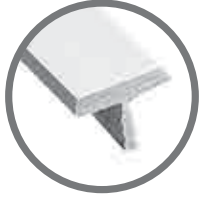

PANEL THICKNESS	LENGTH	SATIN
5/8"	8'	<b>31620810</b>
	12'	<b>31621210</b>

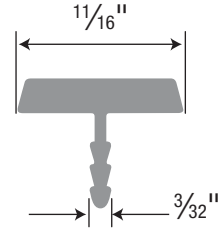

PANEL THICKNESS	LENGTH	SATIN
5/8"	8'	<b>54310810</b>
	12'	<b>54311210</b>

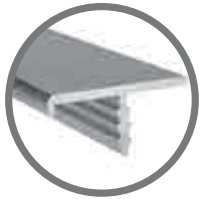
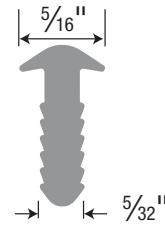

PANEL THICKNESS	LENGTH	SATIN	STAINLESS STEEL
1 3/16"	12'	<b>31951210</b>	<b>319512170</b>

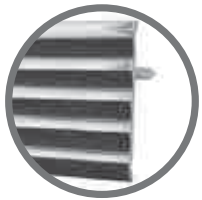
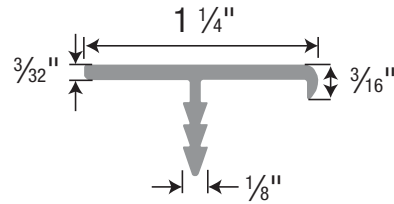

PANEL THICKNESS	LENGTH	BRITE CLEAR
5/8" - 1 1/4"	12'	<b>MRB9680SBC</b>

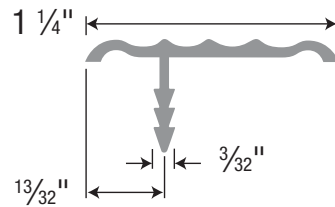

PANEL THICKNESS	LENGTH	SATIN	BRITE CLEAR	STAINLESS STEEL
3/4"	12'	<b>31941210</b>	<b>319412140</b>	<b>319412170</b>

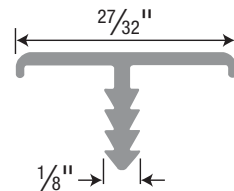

	PANEL THICKNESS	LENGTH	SATIN	STAINLESS STEEL
A	5/8"	12'	<b>32921210</b>	<b>329212170</b>
B	3/4"		<b>31931210</b>	<b>319312170</b>

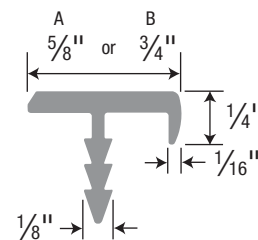

## T-SHAPE



PANEL THICKNESS	LENGTH	SATIN	BRITE CLEAR
3/4"	12'	<b>54821210</b>	<b>548212140</b>

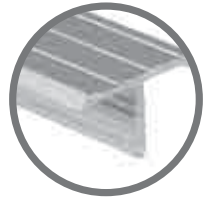
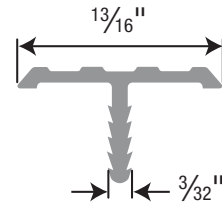

PANEL THICKNESS	LENGTH	BRUSHED
3/4"	12'	<b>MRB1029NS</b>

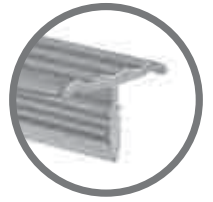
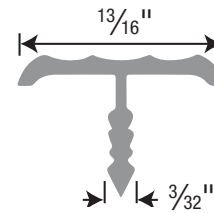

PANEL THICKNESS	LENGTH	SATIN	BRITE CLEAR
1" - 1 1/4"	12'	<b>54841210</b>	<b>548412140</b>

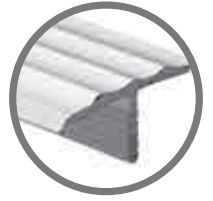
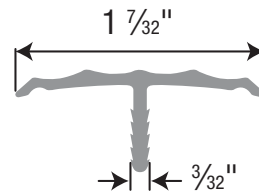

PANEL THICKNESS	LENGTH	SATIN	BRUSHED	BRITE CLEAR
1 1/4"	12'	<b>MRB968NVC</b>	<b>MRB968NS</b>	<b>MRB968NBC</b>

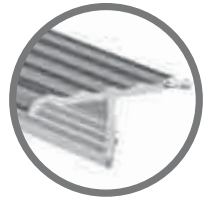
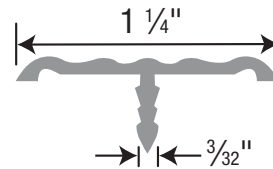

PANEL THICKNESS	LENGTH	SATIN	STAINLESS STEEL
1"	12'	<b>31961210</b>	<b>319612170</b>

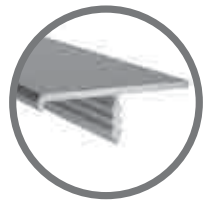
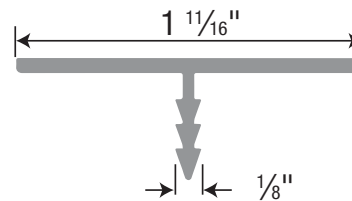

PANEL THICKNESS	LENGTH	SATIN
1 1/4"	12'	<b>MRB968PLVC</b>

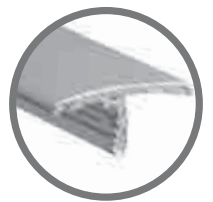
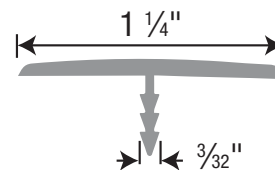

# DECORATIVE PULLS

PULL



	PANEL THICKNESS	LENGTH	SATIN	BRITE CLEAR	STAINLESS STEEL
A	5/8"	12'	<b>31881210</b>	<b>318812140</b>	<b>318812170</b>
B	3/4"		<b>31891210</b>	<b>318912140</b>	<b>318912170</b>

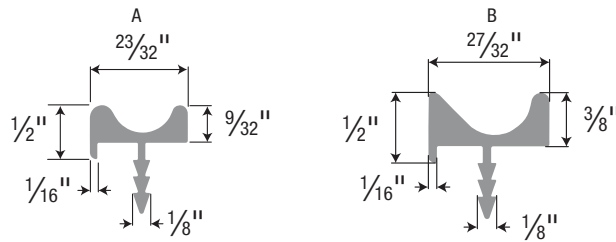
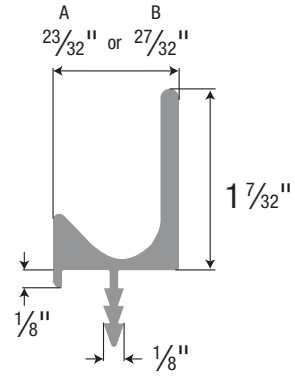

	PANEL THICKNESS	LENGTH	SATIN	BRITE CLEAR	STAINLESS STEEL
A	5/8"	12'	<b>32901210</b>	<b>329012140</b>	<b>329012170</b>
B	3/4"		<b>31871210</b>	<b>318712140</b>	<b>318712170</b>

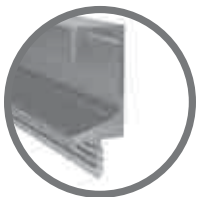

	PANEL THICKNESS	LENGTH	SATIN	STAINLESS STEEL
	5/8"	12'	<b>32001210</b>	<b>320012170</b>

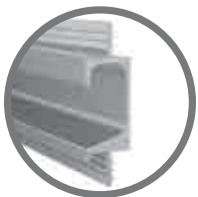
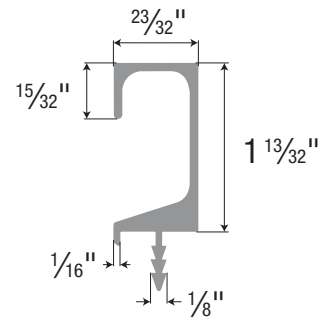

	PANEL THICKNESS	LENGTH	SATIN	STAINLESS STEEL
A	5/8"	12'	<b>32011210</b>	<b>320112170</b>
B	3/4"		<b>32021210</b>	<b>320212170</b>

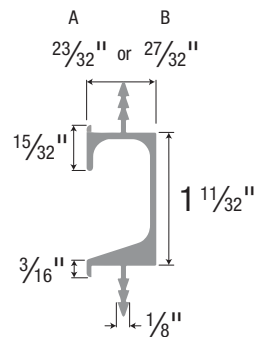

PULL

PANEL THICKNESS	LENGTH	SATIN
5/8" - 3/4"	8'	<b>31820810</b>
	12'	<b>31821210</b>

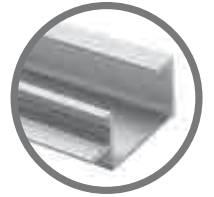
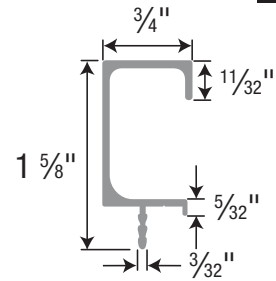

PANEL THICKNESS	LENGTH	SATIN
5/8"	8'	<b>31840810</b>
	12'	<b>31841210</b>

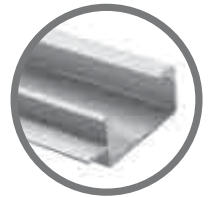
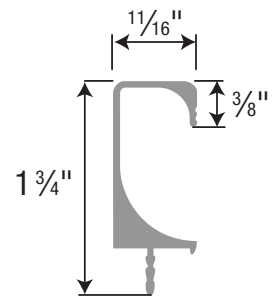

PANEL THICKNESS	LENGTH	SATIN
3/4"	6'	<b>41520610</b>
	12'	<b>41521210</b>

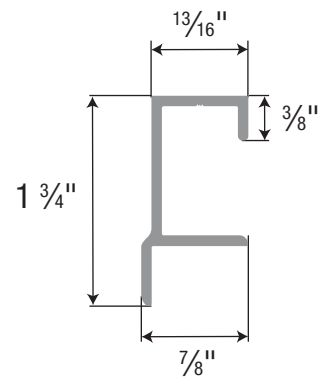

PANEL THICKNESS	LENGTH	SATIN
3/4"	12'	<b>31491210</b>

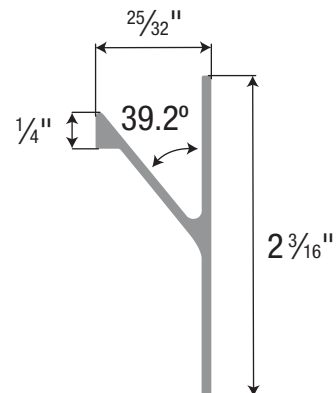

# DECORATIVE PULLS

PULL



PANEL THICKNESS	LENGTH	SATIN	STAINLESS STEEL
5/8" - 3/4"	8'	<b>31860810</b>	<b>318608170</b>
	12'	<b>31861210</b>	<b>318612170</b>

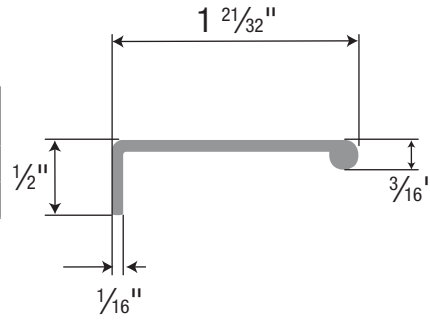

PANEL THICKNESS	LENGTH	SATIN	BRITE CLEAR	STAINLESS STEEL
3/4"	12'	<b>32911210</b>	<b>329112140</b>	<b>329112170</b>

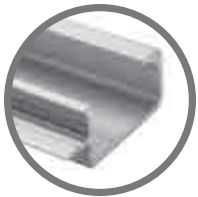
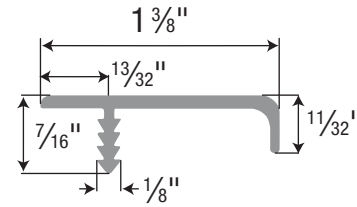

PANEL THICKNESS	LENGTH	SATIN	BRITE CLEAR	STAINLESS STEEL
3/4"	8'	<b>31830810</b>		
	12'	<b>31831210</b>	<b>318312140</b>	<b>319912170</b>
		<b>31991210</b>		

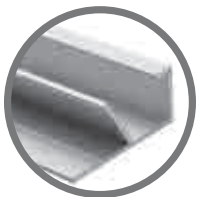
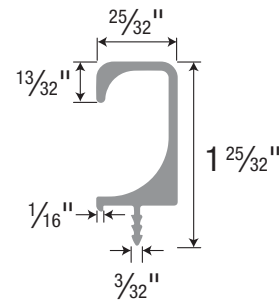

PANEL THICKNESS	LENGTH	SATIN
5/8"	8'	<b>31810810</b>
	12'	<b>31811210</b>

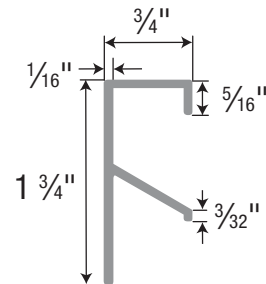



PULL



PANEL THICKNESS	LENGTH	SATIN
5/8"	12'	<b>31851210</b>

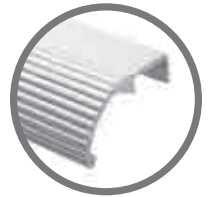
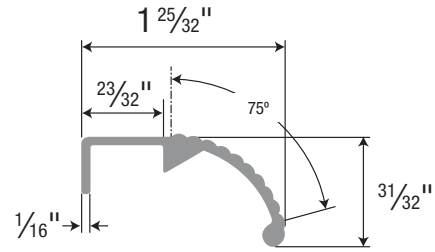

PANEL THICKNESS	LENGTH	SATIN	SATIN BLACK	BRITE CLEAR
3/4"	6'		<b>DP46LBL</b>	<b>DP46LPA</b>
	12'	<b>31791210</b>		

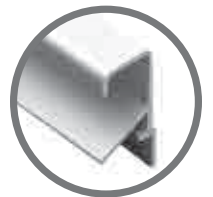
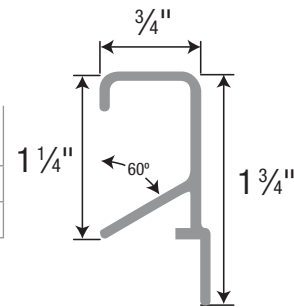

PANEL THICKNESS	LENGTH	SATIN
5/8" - 3/4"	12'	<b>MRB1500SVC</b>

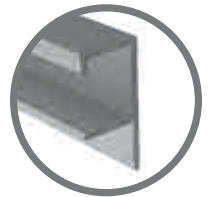
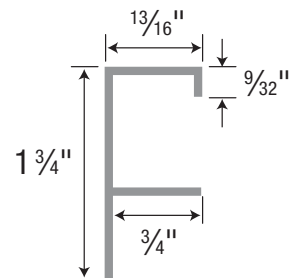

# STAINLESS STEEL DECORATIVE MOLDINGS

## EDGING

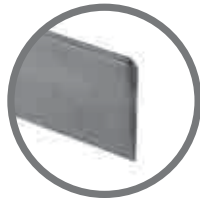

LENGTH	POLISHED	BRUSHED
12'	<b>MRBSS799B</b>	<b>MRBSS799S</b>

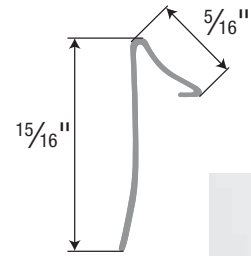

## SNAP-ON EDGING



LENGTH	POLISHED
12'	<b>MRBSS806B</b>

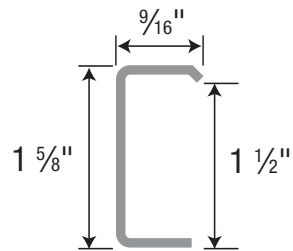

## OUTSIDE CORNER



LENGTH	POLISHED	BRUSHED
12'	<b>MRBSS1452B</b>	<b>MRBSS1452S</b>

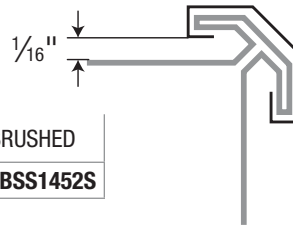

## INSIDE CORNER

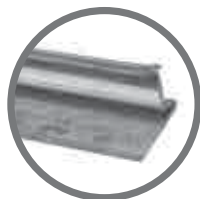

LENGTH	POLISHED
12'	<b>MRBSS1442B</b>

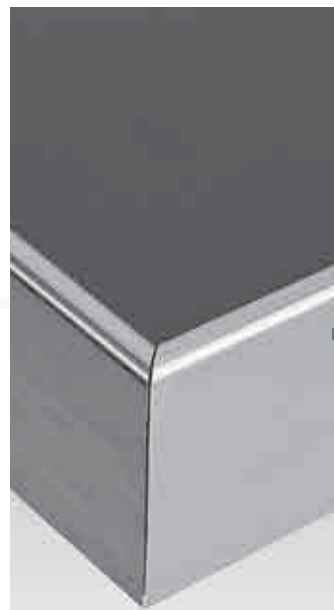
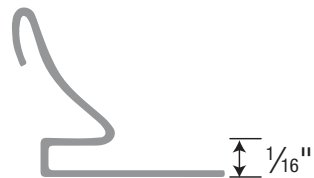

# STAINLESS STEEL DECORATIVE MOLDINGS

# ACCESSORIES

90° ANGLE

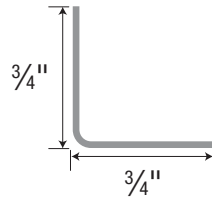
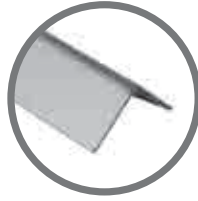

LENGTH	POLISHED
12'	<b>MRBSS369B</b>

J-TRIM

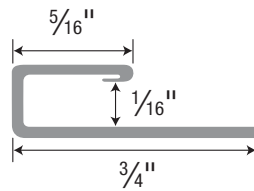
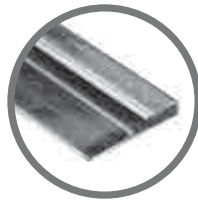

LENGTH	POLISHED	SATIN
8'	<b>MRBSS1451B8</b>	
12'	<b>MRBSS1451B</b>	<b>MRBSS1451S</b>

U-SHAPED

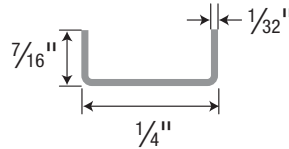
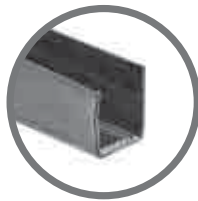

LENGTH	SATIN
12'	<b>MRBSS900S</b>

SEPARATION BAR

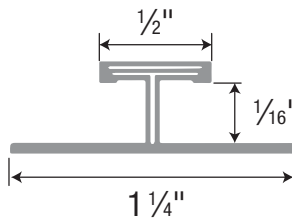
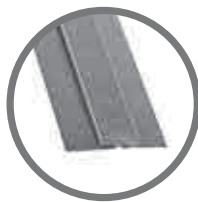

LENGTH	POLISHED	BRUSHED
8'	<b>MRBSS1450B8</b>	
12'	<b>MRBSS1450B</b>	<b>MRBSS1450S</b>

## TREMSIL 200 SILICONE ALUMINUM FINISH

Produces a weathertight seal.

**032310**



## PROGLAZE SILICONE ALUMINUM FINISH

Moisture curing.

**D030064**



## SPECTREM 2 SILICONE ALUMINUM FINISH

Neutral-cure.

**D031260**



## PROTECTIVE WAX FOR ALUMINUM CUTTING

**D030109**



10" SAW BLADE FOR NON-FERROUS METALS

100 TEETH **AT510101C**

60 TEETH **AT510601C**



10" SAW BLADE FOR NON-FERROUS METALS, PLASTICS & PVC

80 TEETH **ATMA10080**

## FUNCTIONAL MOLDINGS

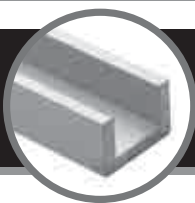

	PAGE
FLAT BAR .....	2
90° .....	2-3
U-SHAPE .....	4
SQUARE TUBE .....	5
ROUND TUBE .....	5
ROD .....	5
Z-PANEL CLIP .....	6
LABELLING .....	6
COMMERCIAL DOOR THRESHOLD .....	6
SLOT WALL INSERT .....	7
CABLE MANAGER .....	7
L-SHAPE .....	8
H-SHAPE .....	8
F-SHAPE .....	8
T-ROD .....	8
DOOR FRAME .....	9
HANGING FILE SUPPORT .....	9
CORNERS .....	9

## MIRROR FINISHING MOLDINGS

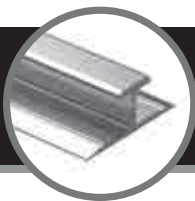

	PAGE
L-SHAPE .....	10
H-SHAPE .....	10
J-SHAPE .....	11
90° CORNER .....	11

## FINISHING MOLDINGS

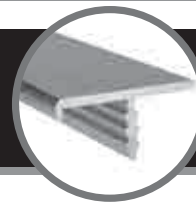

T-SHAPE .....	PAGE 12-13
---------------	---------------

## DECORATIVE PULLS



.....	PAGE 14-17
-------	---------------

## STAINLESS STEEL DECORATIVE MOLDINGS

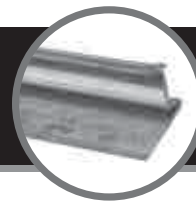

	PAGE
EDGING .....	18
CORNER .....	18
90° ANGLE .....	19
J-TRIM .....	19
U-SHAPE .....	19
SEPARATION BAR .....	19

## ACCESSORIES

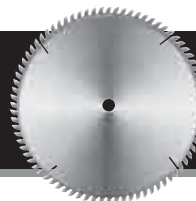

.....	PAGE 19
-------	------------

### CANADA

Tel.: 1 800 361-6000  
Fax: 1 800 363-0193

**ALBERTA**  
Calgary  
Edmonton

**NEW BRUNSWICK**  
Moncton

**ONTARIO**  
Barrie  
Kitchener  
Ottawa  
Sudbury  
Thunder Bay  
Toronto

**QUÉBEC**  
Laval  
Montréal  
Québec

**SASKATCHEWAN**  
Regina  
Saskatoon

**BRITISH COLUMBIA**  
Kelowna  
Vancouver  
Victoria

**NEWFOUNDLAND**  
St. John's

**NOVA SCOTIA**  
Halifax

**MANITOBA**  
Winnipeg

### USA

Tel.: 1 800 619-5446  
Fax: 1 800 876-7454

**CONNECTICUT**  
Hartford

**FLORIDA**  
Dania Beach

Hialeah  
Pompano Beach  
Riviera Beach

**GEORGIA**  
Atlanta  
Savannah

**ILLINOIS**  
Chicago

**INDIANA**  
Indianapolis

**KENTUCKY**  
Louisville

**MASSACHUSETTS**  
Boston

**MICHIGAN**  
Detroit

**NEW JERSEY**  
Avenel  
Lincoln Park

**NEW YORK**  
New York  
Syracuse

**NORTH CAROLINA**  
Charlotte  
Greensboro  
Raleigh

**OHIO**  
Cincinnati  
Cleveland  
Columbus

**SOUTH CAROLINA**  
Greenville

**TENNESSEE**  
Nashville

**WASHINGTON**  
Seattle

