

C-911 HANGER FOR C-104 OR C-108 TRACK

INSTRUCTION SHEET



PARTS LIST

C-911 HANGER
(2 PER DOOR)

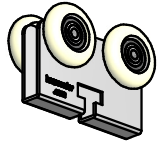

C-911 TOP PLATE
(1 PER HANGER)

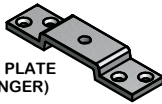

C-911 T-BOLT
(1 PER HANGER)



5/16" HEX NUT
(2 PER HANGER)



C-911 SPINWHEEL
(1 PER HANGER)



#10 X 1-3/4" FLATHEAD SCREWS
(4 PER HANGER)



EXTRUDED ALUMINUM TRACK

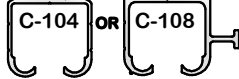

SPECIFICATIONS:
-LOAD CAPACITY:
200 LBS PER DOOR.

-QUICK RELEASE
HANGER ASSEMBLY.

-HEAVY-DUTY PRECISION
BALL BEARING WHEELS
WITH NYLON TIRE.

-EASY LEVELING AND
HEIGHT ADJUSTMENT
ACCOMPLISHED BY
HAND.

-FOR BY-PASSING,
BI-PARTING, POCKET,
AND SURFACE
MOUNT/BARN STYLE
APPLICATIONS.

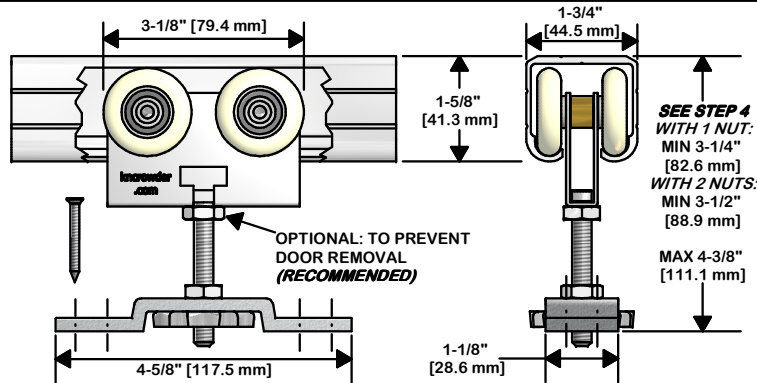

STEP 1

DETERMINE DOOR SIZE/HEADER HEIGHT BASED ON DIMENSIONS SHOWN IN DETAIL VIEWS AND CLEARANCE REQUIRED BELOW DOOR. INSERT C-911 HANGERS INTO TRACK AND SECURE TRACK TO HEADER

STEP 2

A) LOCATE CLEARANCE HOLE FOR HANGER STUD 4-1/2" FROM EACH EDGE OF DOOR. DRILL WITH 3/8" BIT AT LEAST 2" DEEP. IF USING KNC CAS-2 DOOR STOP, LOCATE CLEARANCE HOLE 5-1/2" FROM EDGE OF DOOR.
B) CENTER TOP PLATE OVER HOLE, MARK SCREW HOLE LOCATIONS AND PRE-DRILL WITH 1/8" BIT AT LEAST 1-1/2" DEEP.

STEP 3

PREPARE TOP PLATE ASSEMBLIES (2 SETS) AS FOLLOWS: TOP PLATE (1) WITH T-BOLT(1), 5/16" HEX NUTS (1 OR 2) AND SPIN-WHEEL (1).
♦ONE NUT FOR LOCKING ADJUSTMENT IN PLACE, OPTIONAL SECOND NUT FOR PREVENTING DISCONNECTION FROM HANGER. (RECOMMENDED)

STEP 4

MOUNT TOP PLATE ASSEMBLIES ON DOOR AND SECURE WITH #10 X 1-3/4" FLATHEAD SCREWS (4 PER TOP PLATE).

STEP 5

INSTALL OPTIONAL PRODUCTS IF PURCHASED SUCH AS GUIDE CHANNELS, CUP PULLS, DOOR LOCKS, ETC. INDIVIDUAL INSTRUCTIONS ARE PROVIDED WITH THE RESPECTIVE PRODUCT.

STEP 6

PLACE DOOR UNDER TRACK AND LIFT TO ENGAGE T-BOLTS INTO HANGER SLOTS.

STEP 7

ADJUST DOOR HEIGHT AND PLUMB VIA SPINWHEEL. LOCK ADJUSTMENT BY TIGHTENING HEX NUT AGAINST TOP PLATE. PREVENT UNINTENTIONAL DISCONNECTION OF DOOR FROM HANGER BY LOCKING OPTIONAL SECOND HEX NUT AGAINST UNDERSIDE OF HANGER. (RECOMMENDED)

NOTE: MINIMUM CLEARANCE OF 1/2" REQUIRED BETWEEN DOOR AND FASCIA FOR DISENGAGEMENT.

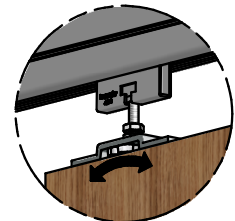
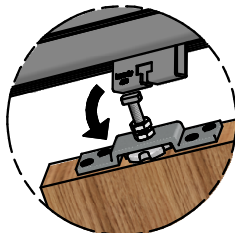
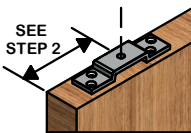

C-911 HANGER FOR C-104 OR C-108 TRACK

INSTRUCTION SHEET



PARTS LIST

C-911 HANGER
(2 PER DOOR)

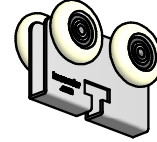

C-911 TOP PLATE
(1 PER HANGER)

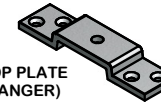

C-911 T-BOLT
(1 PER HANGER)



5/16" HEX NUT
(2 PER HANGER)



C-911 SPINWHEEL
(1 PER HANGER)



#10 X 1-3/4" FLATHEAD SCREWS
(4 PER HANGER)



EXTRUDED ALUMINUM TRACK

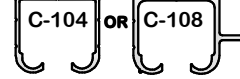

SPECIFICATIONS:
-LOAD CAPACITY:
200 LBS PER DOOR.

-QUICK RELEASE
HANGER ASSEMBLY.

-HEAVY-DUTY PRECISION
BALL BEARING WHEELS
WITH NYLON TIRE.

-EASY LEVELING AND
HEIGHT ADJUSTMENT
ACCOMPLISHED BY
HAND.

-FOR BY-PASSING,
BI-PARTING, POCKET,
AND SURFACE
MOUNT/BARN STYLE
APPLICATIONS.

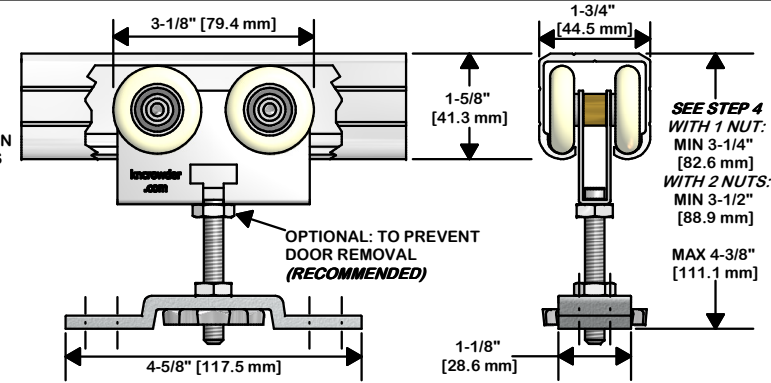

STEP 1

DETERMINE DOOR SIZE/HEADER HEIGHT BASED ON DIMENSIONS SHOWN IN DETAIL VIEWS AND CLEARANCE REQUIRED BELOW DOOR. INSERT C-911 HANGERS INTO TRACK AND SECURE TRACK TO HEADER

STEP 2

A) LOCATE CLEARANCE HOLE FOR HANGER STUD 4-1/2" FROM EACH EDGE OF DOOR. DRILL WITH 3/8" BIT AT LEAST 2" DEEP. IF USING KNC CAS-2 DOOR STOP, LOCATE CLEARANCE HOLE 5-1/2" FROM EDGE OF DOOR.
B) CENTER TOP PLATE OVER HOLE, MARK SCREW HOLE LOCATIONS AND PRE-DRILL WITH 1/8" BIT AT LEAST 1-1/2" DEEP.

STEP 3

PREPARE TOP PLATE ASSEMBLIES (2 SETS) AS FOLLOWS: TOP PLATE (1) WITH T-BOLT(1), 5/16" HEX NUTS (1 OR 2) AND SPIN-WHEEL (1).
♦ONE NUT FOR LOCKING ADJUSTMENT IN PLACE, OPTIONAL SECOND NUT FOR PREVENTING DISCONNECTION FROM HANGER. (RECOMMENDED)

STEP 4

MOUNT TOP PLATE ASSEMBLIES ON DOOR AND SECURE WITH #10 X 1-3/4" FLATHEAD SCREWS (4 PER TOP PLATE).

STEP 5

INSTALL OPTIONAL PRODUCTS IF PURCHASED SUCH AS GUIDE CHANNELS, CUP PULLS, DOOR LOCKS, ETC. INDIVIDUAL INSTRUCTIONS ARE PROVIDED WITH THE RESPECTIVE PRODUCT.

STEP 6

PLACE DOOR UNDER TRACK AND LIFT TO ENGAGE T-BOLTS INTO HANGER SLOTS.

STEP 7

ADJUST DOOR HEIGHT AND PLUMB VIA SPINWHEEL. LOCK ADJUSTMENT BY TIGHTENING HEX NUT AGAINST TOP PLATE. PREVENT UNINTENTIONAL DISCONNECTION OF DOOR FROM HANGER BY LOCKING OPTIONAL SECOND HEX NUT AGAINST UNDERSIDE OF HANGER. (RECOMMENDED)

NOTE: MINIMUM CLEARANCE OF 1/2" REQUIRED BETWEEN DOOR AND FASCIA FOR DISENGAGEMENT.

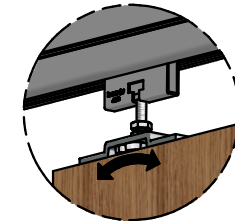
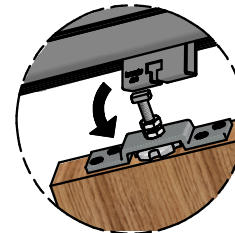
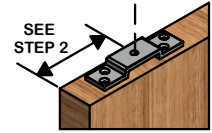

K.N. CROWDER MFG. INC.
1220 BURLOAK DRIVE
BURLINGTON, ONTARIO, CANADA, L7L 6B3
TELEPHONE: 905-315-9788 - FAX: 905-315-8090
TOLL FREE FAX: 1-800-567-0123

K.N. CROWDER INC.
210 EIGHTH STREET SOUTH
LEWISTON, NEW YORK, U.S.A. 14092
TELEPHONE: 1-716-754-8247
TOLL FREE FAX: 1-800-567-0123

WEBSITE: www.kncrowder.com --- E-MAIL: customerservice@kncrowder.com



K.N. CROWDER MFG. INC.
1220 BURLOAK DRIVE
BURLINGTON, ONTARIO, CANADA, L7L 6B3
TELEPHONE: 905-315-9788 - FAX: 905-315-8090
TOLL FREE FAX: 1-800-567-0123

K.N. CROWDER INC.
210 EIGHTH STREET SOUTH
LEWISTON, NEW YORK, U.S.A. 14092
TELEPHONE: 1-716-754-8247
TOLL FREE FAX: 1-800-567-0123

WEBSITE: www.kncrowder.com --- E-MAIL: customerservice@kncrowder.com