

Combination Handle and Towel Bar

Installation Manual

► Measurements

CODE	Material	C/C 1	C/C 2
8702R104822XXX	SUS316	8"	22"

*Available in several finishes

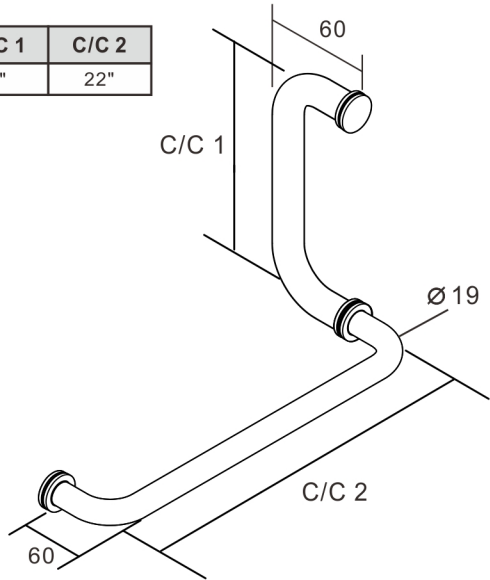
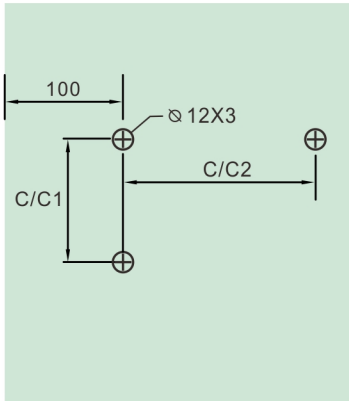

► Components

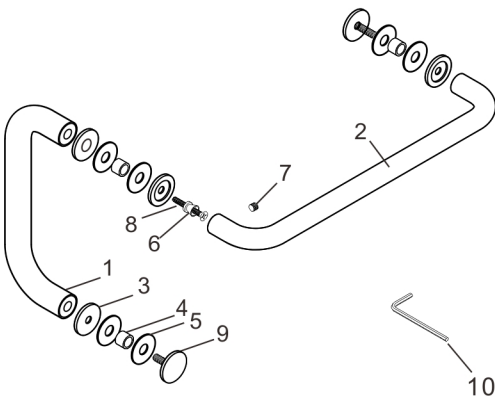

#	Name	Qty
1	Handle	1
2	Towel Bar	1
3	Metal Washer dia32mm	4
4	Plastic Washer	3
5	Gasket	6
6	Collar	1
7	Set Screw M6X6mm	1
8	Screw M6x50mm	1
9	Knob dia32mm	2
10	Allen Key 3mm	1

Combination Handle and Towel Bar

Installation Manual

Install the handle as shown with the screw and collar on the side that will hold the towel bar.

- ★ Phillips screwdriver not included
- ★ Use the 50mm screw for glass doors 6-12mm thick

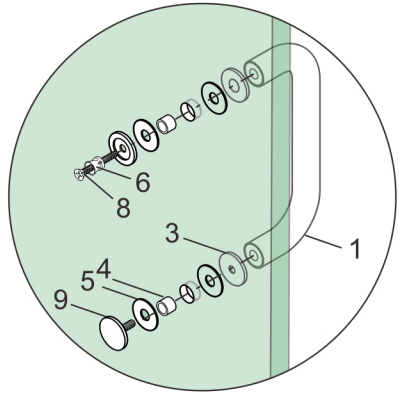

Install the towel bar with the collar on one side and the second knob on the other.

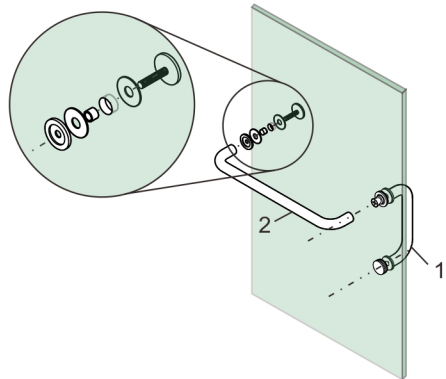

Install the set screws and tighten with the Allen key to finish the installation.

