



# Omega National

P R O D U C T S

THE COMPLETE  
RESOURCE

VOLUME II



# Richelieu

WOOD LAZY SUSANS

HARDWOOD MOULDINGS & CABINETS TRIMS

INTERIOR CABINET ACCESSORIES

EXTERIOR CABINET ACCESSORIES

TAMBOUR DOORS, TRACK SYSTEMS & PANELS

THE SINGLE SOURCE FOR THE MOST COMPREHENSIVE OFFERING  
OF WOOD CABINET ACCESSORIES



## WELCOME TO OMEGA NATIONAL PRODUCTS

Omega National Products is the premier manufacturer and marketer of value-added wood cabinet accessories and related wood products in North America. We manufacture a majority of our products at our plant in Elkhart, IN using rigorous manufacturing processes and quality control standards. We also have manufacturing facilities in Louisville, KY (mirror products) and in Vietnam.

Omega National Products' philosophy is built on forward thinking design, quality workmanship and a passion for making the spaces in which we live more functional, beautiful and comfortable. With an extensive distribution network throughout North America, getting the right product quickly has never been easier.

Through product innovation, marketing and an unparalleled commitment to the highest standards in customer service, Omega National Products will continue to be your single source for wood cabinet accessories.



### Sustainability Seal by Omega National Products

Notice our proud seal throughout this catalog!



The Sustainability Seal by Omega National Products represents our guarantee to you and your customers that the products featuring this seal are manufactured using sustainable resources from only approved chain-of-custody suppliers.

Proud to manufacture a majority of our products in the U.S.A.



**TABLE OF CONTENTS**

<b>CATEGORY</b>	<b>PAGE NUMBERS</b>
<b>WOOD LAZY SUSANS</b>	<b>1 - 6</b>
<b>HARDWOOD MOULDINGS &amp; CABINETS TRIMS</b>	<b>7 - 16</b>
<b>INTERIOR CABINET ACCESSORIES</b>	<b>17 - 21</b>
<b>EXTERIOR CABINET ACCESSORIES</b>	<b>22 - 33</b>
<b>TAMBOUR DOORS, TRACK SYSTEMS &amp; PANELS</b>	<b>34 - 39</b>

The Complete Resource - Volume II, Edition II  
© Copyright 2018 Omega National Products

Omega National Products is proud to be a member of the:



# WOOD LAZY SUSANS

POLE MOUNT SUSANS & NO HOLE SUSANS



## Select Series Susans

- The ultimate interior corner storage solution setting the industry standard for wood lazy susan shelves
- Constructed from 12mm thick shelf multi-directional maple plywood shell
- Wrapped with a high-impact 10 ply maple rim
- Patent pending pole hardware with positive locking pin and heavy duty polymer hub
- Bore and dowel butt joints; no finger joints
- Available in many sizes in full round, kidney or D shape
- 3-shelf kit also available
- All units protected with durable pre-catalyzed UV finish
- Bulk packs available\*

## Pole Mount Susans, Pre-Catalyzed UV Finish — Select Series

PART #	DESCRIPTION	CARTON QTY/ WT	SUG. RETAIL PRICE EACH
T7418K01MNL1	18" Full Round, 1" Rim, 2 Shelves	1 Set/16lbs	\$189.07
T7418K02MNL1	18" Full Round, 1" Rim, 3 Shelves	1 Set/21lbs	\$252.72
T7420K01MNL1	20" Full Round, 1" Rim, 2 Shelves	1 Set/24lbs	\$200.96
T7428K01MNL1	28" Full Round, 1" Rim, 2 Shelves	1 Set/28lbs	\$236.84
T7432K01MNL1	32" Full Round, 1" Rim, 2 Shelves	1 Set/32lbs	\$268.32
T8424K01MNL1	24" Kidney, 1" Rim, Detent, 2 Shelves	1 Set/24lbs	\$214.03
T8428K01MNL1	28" Kidney, 1" Rim, Detent, 2 Shelves	1 Set/28lbs	\$231.50
T8432K01MNL1	32" Kidney, 1" Rim, Detent, 2 Shelves	1 Set/32lbs	\$253.69
T7920K01MNL1	20" D-Shaped, 1" Rim, Detent, 2 Shelves	1 Set/20lbs	\$198.81
T7931K01MNL1	31" D-Shaped, 1" Rim, Detent, 2 Shelves	1 Set/30lbs	\$265.67

## Pole-Mount Hardware Kits

PART #	DESCRIPTION	CARTON QTY/ WT	SUG. RETAIL PRICE EACH
TPH02	For 2 shelf applications	10 Sets/2lbs	\$67.95
TPH03	For 3 shelf applications	10 Sets/3lbs	\$94.04

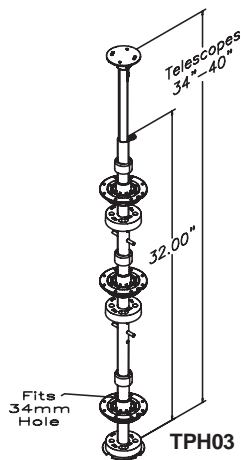
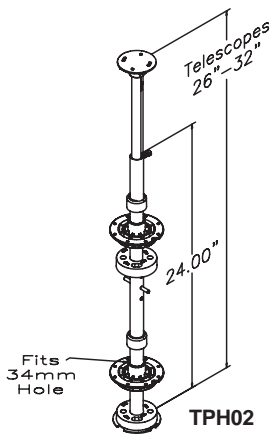

## Pole Mount Susans, Pre-Catalyzed UV Finish — Select Series (Shelves only)

**VOLUME PRICING**

PART #	DESCRIPTION	CARTON QTY	SUG. RETAIL PRICE EACH
T7418MNL5	18" Full Round Shelf, 1" Rim	23/Skid	\$50.08
T7420MNL5	20" Full Round Shelf, 1" Rim	23/Skid	\$54.29
T7428MNL5	28" Full Round Shelf, 1" Rim	23/Skid	\$72.73
T7432MNL5	32" Full Round Shelf, 1" Rim	23/Skid	\$90.17
T8424MNL5	24" Kidney Shelf, 1" Rim, Detent	23/Skid	\$79.19
T8428MNL5	28" Kidney Shelf, 1" Rim, Detent	23/Skid	\$72.07
T8432MNL5	32" Kidney Shelf, 1" Rim, Detent	23/Skid	\$83.68
T7920MNL5	20" D-Shaped, 1" Rim, Detent	23/Skid	\$78.09
T7931MNL5	31" D-Shaped, 1" Rim, Detent	23/Skid	\$117.37

## Wood Lazy Susan Kits — Shelves Only No Holes, No Bearings

PART #	DESCRIPTION	CARTON QTY	SUG. RETAIL PRICE EACH
T8932K05MNL1	32" Kidney, No Bearing, No Hole	2 Shelves	\$183.99
T7632K05MNL1	32" Full Round, No Bearing, No Hole	2 Shelves	\$198.90
T8928K05MNL1	28" Kidney, No Bearing, No Hole	2 Shelves	\$162.40
T7628K05MNL1	28" Full Round, No Bearing, No Hole	2 Shelves	\$165.52
T7618K05MNL1	18" Full Round, No Bearing, No Hole	2 Shelves	\$89.04

## Wood Lazy Susan Kits — Shelves Only No Holes, No Bearings (Bulk)

**VOLUME PRICING**

PART #	DESCRIPTION	CARTON QTY	SUG. RETAIL PRICE EACH
T8932MNL5	32" Kidney, No Bearing, No Hole	23/Skid	\$80.84
T7632MNL5	32" Full Round, No Bearing, No Hole	23/Skid	\$88.30
T8928MNL5	28" Kidney, No Bearing, No Hole	23/Skid	\$69.89
T7628MNL5	28" Full Round, No Bearing, No Hole	23/Skid	\$71.60
T7618MNL5	18" Full Round, No Bearing, No Hole	23/Skid	\$52.45



# WOOD LAZY SUSANS

## SELECT SERIES SUPER SUSANS

Courtesy Weilborn Cabinet Co.



### Select Series Super Susans

- The ultimate interior corner storage solution setting the industry standard for wood lazy susan shelves
- Constructed from 12mm thick shelf multi-directional maple plywood shell
- Wrapped with a high-impact 10 ply maple rim
- Premounted bearing swivel and mounting plate
- Bore and dowel butt joints; no finger joints
- Available in many sizes in full round, kidney or D shape
- Designed for fixed shelf applications
- All units protected with durable pre-catalyzed UV finish
- Bulk packs available\*

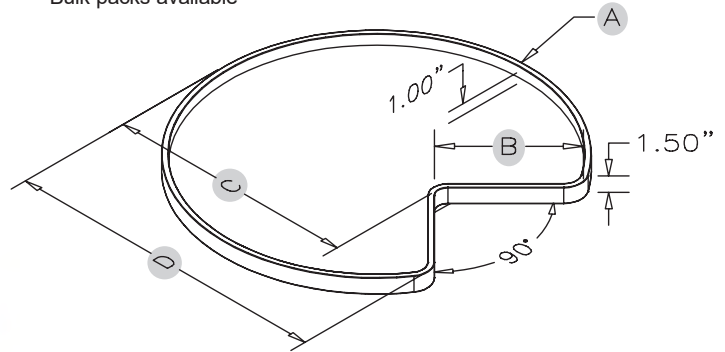

	A	B	C	D
T8224:	24.00"	10.64"	14.33"	20.77"
T8228:	28.00"	9.20"	20.38"	26.01"
T8232:	32.00"	11.28"	22.38"	29.45"

### Two-Shelf Super Susan Kits — Select Series

PART #	DESCRIPTION	CARTON QTY/ WT	SUG. RETAIL PRICE EACH
<b>All kits come with two shelves pre-assembled with swivel bearing and mounting plate</b>			
T7218K30MNL1	18" Full Round, 1" Rim, 9" Bearing	1 Set/18lbs	\$151.13
T7228K30MNL1	28" Full Round, 1" Rim, 9" Bearing	1 Set/28lbs	\$194.50
T7232K30MNL1	32" Full Round, 1" Rim, 12" Bearing	1 Set/35lbs	\$239.62
T8224K30MNL1	24" Kidney, 1" Rim, No Detent, 4" Bearing	1 Set/25lbs	\$175.50
T8228K30MNL1	28" Kidney, 1" Rim, Detent, 9" Bearing	1 Set/28lbs	\$199.43
T8332K30MNL1	32" Kidney, 1" Rim, Detent, 12" Bearing	1 Set/35lbs	\$229.26

### Super Susans Volume Pricing — Select Series

**VOLUME PRICING**

PART #	DESCRIPTION	CARTON QTY/ WT	SUG. RETAIL PRICE EACH
<b>Pre-assembled with swivel bearing and mounting plate</b>			
T7218MNL5	18" Full Round, 1" Rim, 9" Bearing	23/Skid	\$61.21
T7228MNL5	28" Full Round, 1" Rim, 9" Bearing	23/Skid	\$82.99
T7232MNL5	32" Full Round, 1" Rim, 12" Bearing	23/Skid	\$102.65
T8224MNL5	24" Kidney, 1" Rim, Detent, 4" Bearing	23/Skid	\$71.76
T8228MNL5	28" Kidney, 1" Rim, Detent, 9" Bearing	23/Skid	\$82.21
T8332MNL5	32" Kidney, 1" Rim, Detent, 12" Bearing	23/Skid	\$96.88



Omega National  
PRODUCTS

# WOOD LAZY SUSANS

SELECT SERIES SUSANS - 1-3/4" LIP



## Select Series Susan – 1-3/4" lip, Maple

- Industry leading Select Series Wood Lazy Susan
- Highest quality, best operating Wood Lazy Susan available
- Increased lip height from 1" to 1-3/4"
- Available in 18", 28" and 32" full round, and 28" and 32" kidney
- Pre-mounted on our patented diecast aluminum bearing for ultra smooth movement
- Bore and dowel butt joints; no finger joints
- 360lb weight capacity
- Features a high-impact 10 ply maple rim and 12 mm multi-directional plywood shelf
- Designed for fixed shelf applications

## Select Series Susan – 1-3/4" Lip

PART #	DIMENSIONS	CARTON QTY/ WT	SUG. RETAIL PRICE EACH
<b>Super Susan w/Attached Cast Bearing 2 Shelf Kit</b>			
T7218K30DCBMNL1	18" Full Rnd (1" Lip Only)	1 set/20lbs	\$174.72
T7228K30TRDCBMNL1	28" Full Round	1 set/45lbs	\$243.36
T7232K30TRDCBMNL1	32" Full Round	1 set/53lbs	\$258.96
T8228K30TRDCBMNL1	28" Kidney	1 set/42lbs	\$241.02
T8332K30TRDCBMNL1	32" Kidney	1 set/52lbs	\$258.96
<b>Super Susan w/attached Cast Bearing Bulk Pack</b>			
T7218DCBMNL5	18" Full Rnd (1" Lip Only)	16 ea/160lbs	\$75.54
T7228TRDCBMNL5	28" Full Round	16 ea/450lbs	\$106.05
T7232TRDCBMNL5	32" Full Round	16 ea/530lbs	\$114.07
T8228TRDCBMNL5	28" Kidney	16 ea/420lbs	\$112.48
T8332TRDCBMNL5	32" Kidney	16 ea/520lbs	\$120.53

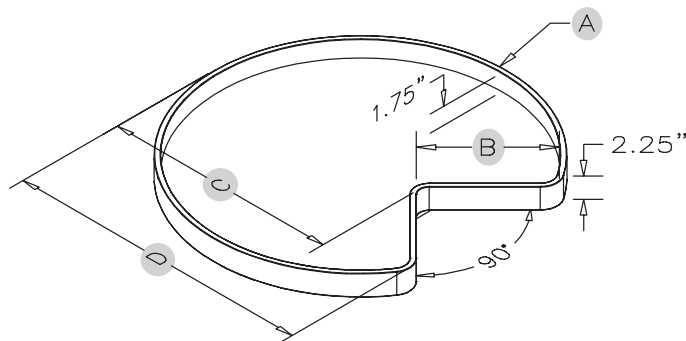

	A	B	C	D
T8228:	28.00"	9.20"	20.38"	26.01"
T8332:	32.00"	11.28"	22.38"	29.45"



# WOOD LAZY SUSANS

DEEP BIN SUSANS - 6" LIP



### Deep Bin Super Susan, Maple

- Revolutionary design; truly one of a kind corner solution
- 30" pie-cut with attached patented diecast aluminum bearing
- Hard maple and birch construction
- Bore and dowel butt joints; no finger joints
- Features solid maple rim front and 12 mm multi-directional plywood shelf
- Designed for fixed shelf applications

Ideal for kitchen appliances and bulk food storage!

### 6" Lip Deep Bin Super Susan

PART #	CARTON QTY/ WT	SUG. RETAIL PRICE EACH
<b>30" Pie Cut w/attached Cast Bearing</b>		
T8530K30TR6DCBMNL1	1 piece/20lbs	\$209.04

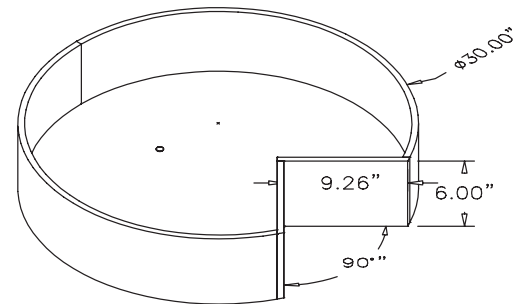

# WOOD LAZY SUSANS

## PLATINUM SERIES SUSANS & 10" SPICE SUSAN



### Platinum Series™ Wood Lazy Susans

- The ultimate interior corner storage solution featuring our new Platinum Series Powdercoat Wire Rim
- Inside height 3"
- Attached bearing swivel and mounting plate
- Bore and dowel butt joints; no finger joints
- Constructed from 12 mm thick shelf multi-directional Maple plywood shell and wrapped with a high-impact 10 ply Maple rim
- Available in full round and kidney
- Designed for fixed shelf applications

The Wood Lazy Susans listed below feature our new Platinum Series™ Powdercoat Wire Rim:

### Platinum Series™ Wood Lazy Susans

PART #	2-SHELF KIT DESCRIPTION	SUG. RETAIL PRICE EACH
T7228K04PFMNL1	28" Full Round w/bearing - 2 shelves	\$271.44
T7232K04PFMNL1	32" Full Round w/bearing - 2 shelves	\$338.83
T8228K04PFMNL1	28" Kidney w/bearing and detent - 2 shelves	\$271.44
T8332K04PFMNL1	32" Kidney w/bearing and detent - 2 shelves	\$313.62

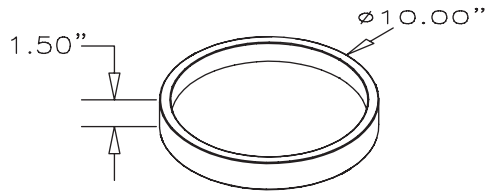

### 10" Select Spice Susan, Maple

- 10" diameter and designed for spice storage
- Perfect for 12" deep cabinets
- Available individually with a 4" bearing attached with non-slip feet
- Ideal for spices, but designed for many storage applications
- Individual Susans can be taken with you to your preparation or grill area
- 1" lip, plywood core



### 10" Select Spice Susan

PART #	CARTON QTY/ WT	SUG. RETAIL PRICE EACH
<b>10" Spice Susan with Bearing Attached</b>		
T7210MNL1	1 piece/3lbs	\$33.73



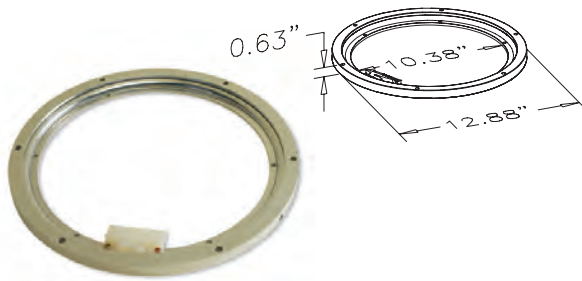

### 12" Cast Aluminum Bearing

(Patent Pending)

- Manufactured with 98 ball bearings for the smoothest susan operation
- Heavy duty and ultra quiet
- Comes with a removable detent\*
- 360 lb capacity

### 12" Cast Aluminum Turntable Bearing - 360 lb Capacity

PART #	DESCRIPTION	CARTON QTY/ WT	SUG. RETAIL PRICE EACH
B41848UF5*	12" Cast Bearing with Detent (Bulk)	25 Pieces/30lbs	\$29.28

\*Optional detent  
Install with any #8 flat head wood screw

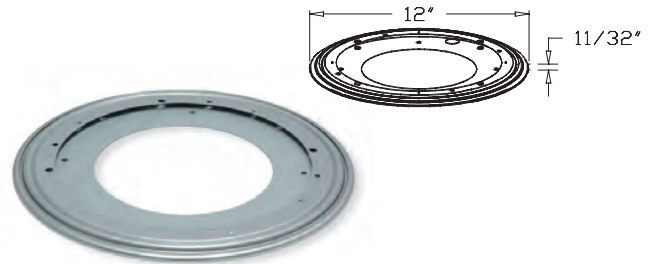

### 12" Steel Turntable Bearing

- Features 1,000 lb capacity
- 360° ball bearing rotation and detent stop

### 12" Steel Turntable Bearing

PART #	DESCRIPTION	CARTON QTY/ WT	SUG. RETAIL PRICE EACH
B41850UF5	12" steel bearing	25 Sets/45lbs	\$12.60



### Lazy Susan Pole Hardware

- Durable, functional and simple to install
- High quality polished stainless steel finish and tight-tolerance collars ensure long life and durability
- Two shelf kit telescopes from 26" - 32" and three shelf kit telescopes from 34" - 40"
- All pole hardware features independently rotating pivots and hardware
- Installation instructions included
- All pole hardware passes ANSI/BHMA grade 1 rating

### Lazy Susan Pole-Mount Hardware Kits

PART #	DESCRIPTION	CARTON QTY/ WT	SUG. RETAIL PRICE EACH
TPH02	For 2 shelf applications	10 Sets/2lbs	\$67.95
TPH03	For 3 shelf applications	10 Sets/3lbs	\$94.04

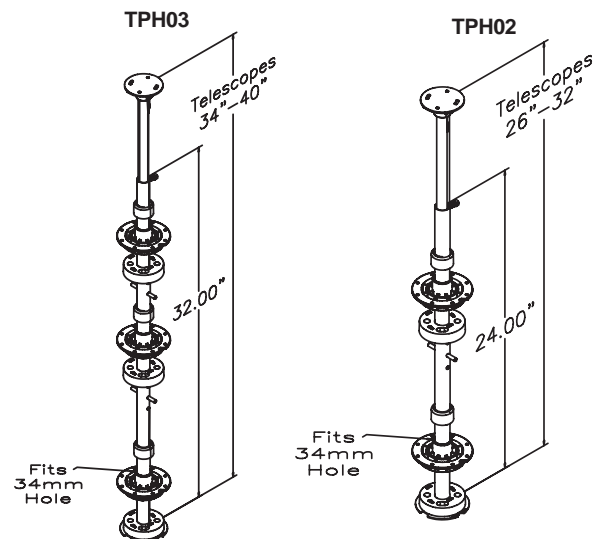



### Split Rope Moulding

- Well known for high quality and true machining
- Sanded by hand and blemish-free to ensure superior workmanship and 100% yield
- Available in 3/8", 1/2", 3/4", 1" and 1-1/2" widths in 8 ft lengths
- Offered in 5 species
- Small quantity and random lengths also available

### Split Rope Moulding

PART #	SPECIES	CARTON QTY/ WT	SUG. RETAIL PRICE EACH
<b>3/8" x 3/16", 96" Length</b>			
M0050OUF2	Red Oak	25 pieces/5lbs	\$14.25
M0050OUF8	Red Oak	4 pieces/1lb	\$16.37
M0050MUF2	Maple	25 pieces/5lbs	\$16.89
M0050MUF8	Maple	4 pieces/1lb	\$19.42
M0050HUF2	Hickory	25 pieces/5lbs	\$13.87
M0050HUF8	Hickory	4 pieces/1lb	\$15.95
M0050CUF2	Cherry	25 pieces/5lbs	\$19.87
M0050CUF8	Cherry	4 pieces/1lb	\$22.89
M0050QUF2	Alder	25 pieces/5lbs	\$16.40
M0050QUF8	Alder	4 pieces/1lb	\$18.83
<b>1/2" x 7/32", 96" Length</b>			
M0051OUF2	Red Oak	25 pieces/8lbs	\$13.98
M0051OUF8	Red Oak	4 pieces/11lbs	\$16.06
M0051MUF2	Maple	25 pieces/8lbs	\$16.61
M0051MUF8	Maple	4 pieces/11lbs	\$19.11
M0051HUF2	Hickory	25 pieces/8lbs	\$13.56
M0051HUF8	Hickory	4 pieces/11lbs	\$15.57
M0051CUF2	Cherry	25 pieces/8lbs	\$19.46
M0051CUF8	Cherry	4 pieces/11lbs	\$22.37
M0051QUF2	Alder	25 pieces/8lbs	\$16.16
M0051QUF8	Alder	4 pieces/11lbs	\$18.55

### Split Rope Moulding (Cont.)

PART #	SPECIES	CARTON QTY/ WT	SUG. RETAIL PRICE EACH
<b>3/4" x 5/16", 96" Length</b>			
M0052OUF2	Red Oak	25 pieces/5lbs	\$15.88
M0052OUF8	Red Oak	4 pieces/1lb	\$18.24
M0052MUF2	Maple	25 pieces/5lbs	\$19.32
M0052MUF8	Maple	4 pieces/1lb	\$22.19
M0052HUF2	Hickory	25 pieces/5lbs	\$15.33
M0052HUF8	Hickory	4 pieces/1lb	\$17.65
M0052CUF2	Cherry	25 pieces/5lbs	\$22.92
M0052CUF8	Cherry	4 pieces/1lb	\$26.32
M0052QUF2	Alder	25 pieces/5lbs	\$18.73
M0052QUF8	Alder	4 pieces/1lb	\$21.54
<b>1" x 7/16", 96" Length</b>			
M0040OUF2	Red Oak	4 pieces/2lbs	\$25.73
M0040MUF2	Maple	4 pieces/2lbs	\$32.29
M0040HUF2	Hickory	4 pieces/2lbs	\$26.22
M0040CUF2	Cherry	4 pieces/2lbs	\$41.58
<b>1-1/2" x 11/16", 96" Length</b>			
M0044OUF2	Red Oak	4 pieces/2lbs	\$75.91
M0044MUF2	Maple	4 pieces/2lbs	\$81.50
M0044HUF2	Hickory	4 pieces/2lbs	\$77.68
M0044CUF2	Cherry	4 pieces/2lbs	\$114.51
M0044QUF2	Alder	4 pieces/2lbs	\$79.14



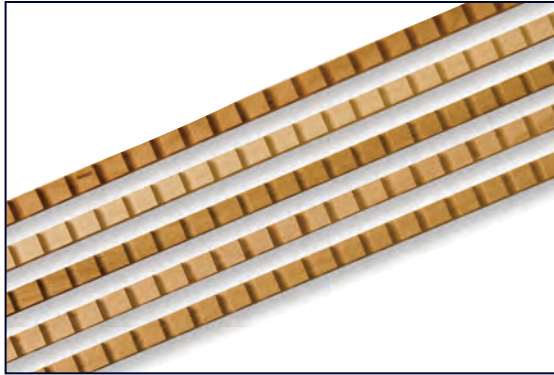

### Dentil Moulding

- Milled from the same high grade lumber as our rope mouldings
- Hand sanded and blemish-free to ensure superior craftsmanship and 100% yield
- Available in 3/4" and 5/8" widths in 8 ft lengths or 4 ft lengths
- Offered in 5 different species

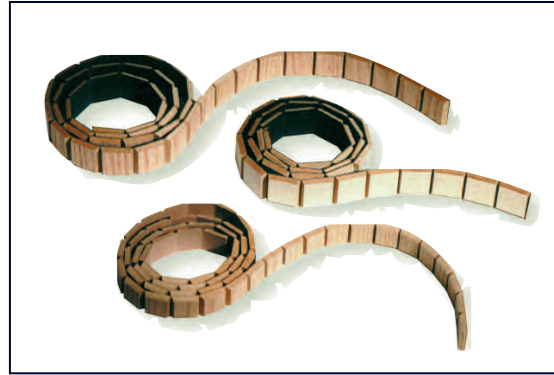

### Flexible Dentil Moulding

- Decorative flexible trim strip similar to dentil moulding
- Ideal for flat or tight-radius curved surfaces on desks, curios and other cabinets, crown moulding, and many other types of applications
- Consists of wood veneer surface-bonded to fiberboard core with flexible backer
- Available in 3/4" and 1" blocks

## Dentil Moulding - Unfinished

PART #	SPECIES	CARTON QTY/ WT	SUG. RETAIL PRICE EACH
<b>3/4"W x 1/2"TH x 96"L</b>			
M0061OUF2	Red Oak	15 pieces/16lbs	\$33.71
M0061OUF8	Red Oak	4 pieces/4lbs	\$38.74
M0061MUF2	Maple	15 pieces/16lbs	\$40.26
M0061MUF8	Maple	4 pieces/4lbs	\$46.30
M0061HUF2	Hickory	15 pieces/16lbs	\$34.44
M0061HUF8	Hickory	4 pieces/4lbs	\$39.60
M0061CUF2	Cherry	15 pieces/16lbs	\$44.70
M0061CUF8	Cherry	4 pieces/4lbs	\$51.43
M0061QUF2	Alder	15 pieces/16lbs	\$37.14
M0061QUF8	Alder	4 pieces/4lbs	\$42.72
<b>3/4"W x 1/2"TH x 48"L</b>			
M0062OUF2	Red Oak	15 pieces/8lbs	\$15.64
M0062MUF2	Maple	15 pieces/8lbs	\$18.97
M0062HUF2	Hickory	15 pieces/8lbs	\$14.91
M0062CUF2	Cherry	15 pieces/8lbs	\$21.12
<b>5/8"W x 1/4"TH x 96"L</b>			
M8398OUF2	Red Oak	25 pieces/8lbs	\$14.08
M8398OUF8	Red Oak	4 pieces/2lbs	\$16.20
M8398MUF2	Maple	25 pieces/8lbs	\$18.48
M8398MUF8	Maple	4 pieces/2lbs	\$21.26
M8398HUF2	Hickory	25 pieces/8lbs	\$14.36
M8398HUF8	Hickory	4 pieces/2lb	\$16.51
M8398CUF2	Cherry	25 pieces/8lbs	\$20.67
M8398CUF8	Cherry	4 pieces/2lbs	\$23.79
M8398QUF2	Alder	25 pieces/8lb	\$15.81
M8398QUF8	Alder	4 pieces/2lbs	\$20.43

## Flexible Dentil Moulding

PART #	DIMENSIONS	SPECIES	CARTON QTY/ WT	SUG. RETAIL PRICE EACH
<b>47" Flexible Dentil Moulding 3/16"TH</b>				
DENTRO-.75	3/4" block	Red Oak	35 pieces/17lbs	\$6.42
DENTMA-.75	3/4" block	Maple	35 pieces/17lbs	\$6.62
DENTCH-.75	3/4" block	Cherry	35 pieces/17lbs	\$7.49
DENTRO-1.0	1" block	Red Oak	35 pieces/17lbs	\$6.42
DENTMA-1.0	1" block	Maple	35 pieces/17lbs	\$6.62
DENTCH-1.0	1" block	Cherry	35 pieces/17lbs	\$7.49



# HARDWOOD MOULDINGS & CABINETY TRIMS

## 8' & 12' CROWN MOULDING

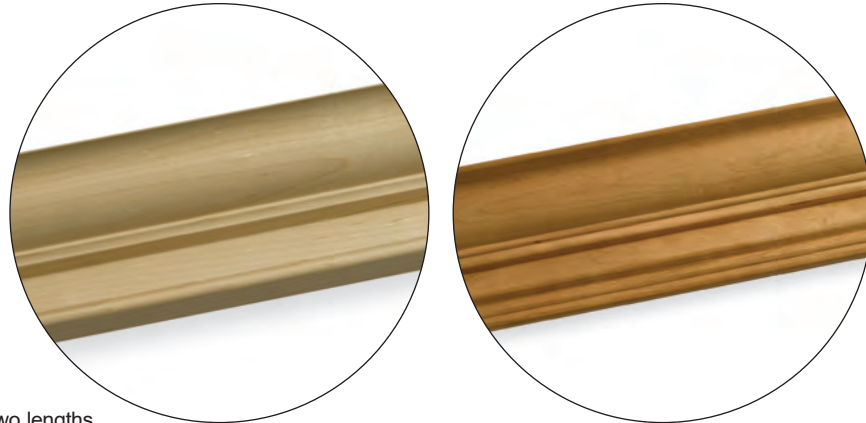

### Crown Moulding

- High quality solid wood
- Available in two profiles and two lengths
- 5 wood species
- No splices, no blemishes
- 100% yield from each piece

### 8' Crown Moulding - Unfinished

PART #	DIMENSIONS	SPECIES	CARTON QTY/ WT	SUG. RETAIL PRICE EACH
<b>96" Length</b>				
M0491OUF2	4.09" x .8125"	Red Oak	12 pieces/80lbs	\$78.38
M0491OUF8	4.09" x .8125"	Red Oak	4 pieces/27lbs	\$90.13
M0468OUF2	3" x .769"	Red Oak	10 pieces/37lbs	\$62.08
M0468OUF8	3" x .769"	Red Oak	4 pieces/15lbs	\$71.40
M0491MUF2	4.09" x .8125"	Maple	12 pieces/80lbs	\$99.46
M0491MUF8	4.09" x .8125"	Maple	4 pieces/27lbs	\$114.41
M0468MUF2	3" x .769"	Maple	10 pieces/37lbs	\$86.63
M0468MUF8	3" x .769"	Maple	4 pieces/15lbs	\$99.60
M0491HUF2	4.09" x .8125"	Hickory	12 pieces/80lbs	\$78.03
M0491HUF8	4.09" x .8125"	Hickory	4 pieces/27lbs	\$89.72
M0468HUF2	3" x .769"	Hickory	10 pieces/37lbs	\$58.54
M0468HUF8	3" x .769"	Hickory	4 pieces/15lbs	\$67.31
M0491CUF2	4.09" x .8125"	Cherry	12 pieces/80lbs	\$138.93
M0491CUF8	4.09" x .8125"	Cherry	4 pieces/27lbs	\$159.77
M0468CUF2	3" x .769"	Cherry	10 pieces/37lbs	\$111.42
M0468CUF8	3" x .769"	Cherry	4 pieces/15lbs	\$128.11
M0491QUF2	4.09" x .8125"	Alder	12 pieces/80lbs	\$81.25
M0491QUF8	4.09" x .8125"	Alder	4 pieces/27lbs	\$93.43
M0468QUF2	3" x .769"	Alder	10 pieces/37lbs	\$56.49
M0468QUF8	3" x .769"	Alder	4 pieces/15lbs	\$64.99

### 12' Crown Moulding - Unfinished

PART #	DIMENSIONS	SPECIES	CARTON QTY/ WT	SUG. RETAIL PRICE EACH
<b>144" Length</b>				
M0492OUF2	4.09" x .8125"	Red Oak	6 pieces/45lbs	\$126.44
M0492MUF2	4.09" x .8125"	Maple	6 pieces/45lbs	\$169.48
M0492HUF2	4.09" x .8125"	Hickory	6 pieces/45lbs	\$149.47
M0492CUF2	4.09" x .8125"	Cherry	6 pieces/45lbs	\$229.44

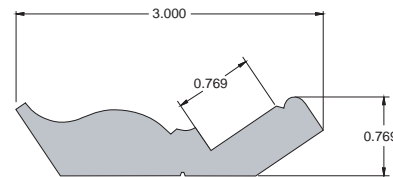
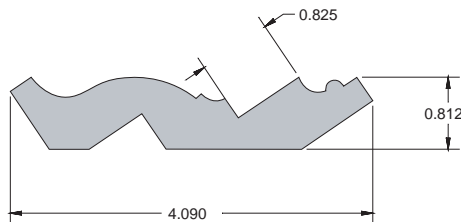



# HARDWOOD MOULDINGS & CABINETRY TRIMS

## CROWN WITH ROPE / DENTIL



### Crown Moulding with Rope

- Hand sanded, 100% yield and ready-to-finish
- Combine our top quality crown with our top quality rope moulding to achieve a completely custom look

### Crown with Rope

PART #	DIMENSIONS	SPECIES	CARTON QTY/ WT	SUG. RETAIL PRICE EACH
<b>96" Crown with 3/4" Rope Assembled</b>				
MA04981OUF8	4.09" x .75"	Red Oak	4 pieces/28lbs	\$130.67
MA04681OUF8	3" x .75"	Red Oak	4 pieces/16lbs	\$99.15
MA04981MUF8	4.09" x .75"	Maple	4 pieces/28lbs	\$162.44
MA04681MUF8	3" x .75"	Maple	4 pieces/16lbs	\$123.49
MA04981CUF8	4.09" x .75"	Cherry	4 pieces/28lbs	\$196.49
MA04681CUF8	3" x .75"	Cherry	4 pieces/16lbs	\$149.61
MA04981HUF8	4.09" x .75"	Hickory	4 pieces/28lbs	\$134.31
MA04681HUF8	3" x .75"	Hickory	4 pieces/16lbs	\$101.96
MA04981QUF8	4.09" x .75"	Alder	4 pieces/28lbs	\$149.61
MA04681QUF8	3" x .75"	Alder	4 pieces/16lbs	\$113.37

### Crown Moulding with Dentil

- Hand sanded, 100% yield and ready-to-finish
- Combine our top quality crown with our top quality dentil moulding to achieve a completely custom look

### Crown with Dentil

PART #	DIMENSIONS	SPECIES	CARTON QTY/ WT	SUG. RETAIL PRICE EACH
<b>96" Crown with 3/4" Dentil Assembled</b>				
MA04982OUF8	4.09" x .75"	Red Oak	4 pieces/29lbs	\$115.91
MA04682OUF8	3" x .75"	Red Oak	4 pieces/17lbs	\$101.12
MA04982MUF8	4.09" x .75"	Maple	4 pieces/29lbs	\$143.06
MA04682MUF8	3" x .75"	Maple	4 pieces/17lbs	\$124.78
MA04982CUF8	4.09" x .75"	Cherry	4 pieces/29lbs	\$118.97
MA04682CUF8	3" x .75"	Cherry	4 pieces/17lbs	\$150.06
MA04982HUF8	4.09" x .75"	Hickory	4 pieces/29lbs	\$172.12
MA04682HUF8	3" x .75"	Hickory	4 pieces/17lbs	\$103.83
MA04982QUF8	4.09" x .75"	Alder	4 pieces/29lbs	\$133.70
MA04682QUF8	3" x .75"	Alder	4 pieces/17lbs	\$123.28

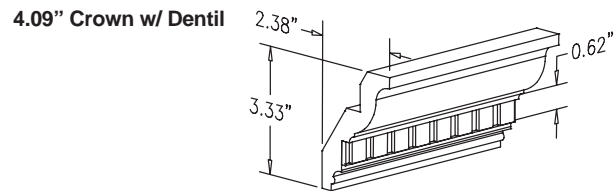
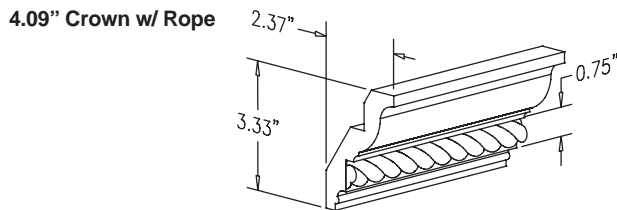
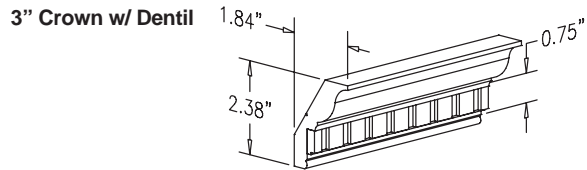
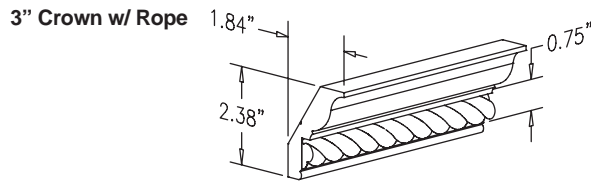

# HARDWOOD MOULDINGS & CABINETS TRIMS

## EMBOSSED MOULDINGS



**E022E5**  
3/4"W x 1/2"TH x 96"L



**E010E5**  
1/2"W x .313"TH x 96"L



**E024D2**  
1/2"W x .313"TH x 96"L

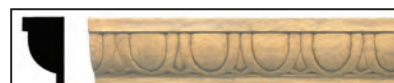

**E023E4**  
3/4"W x 1/2"TH x 96"L



**E029F1**  
3/4"W x .313"TH x 96"L



**E039E2**  
1"W x .309"TH x 96"L

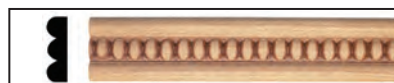

**E359P2**  
3/4"W x .280"TH x 96"L

### Embossed Mouldings

- Extensive collection of Solid Wood Embossed Mouldings
- Elegant and versatile
- Insert into crown or cabinet trim moulding for a completely custom look
- Available in Red Oak, Maple, and Cherry

### Embossed Mouldings - Unfinished

PART #	SPECIES	CARTON QTY/ WT	SUG. RETAIL PRICE EACH
<b>E022E5 - 3/4"W x 1/2"TH x 96"L</b>			
E022E5960UF8	Red Oak	4 pieces/2lbs	\$25.28
E022E5960MUF8	Maple	4 pieces/2lbs	\$31.87
E022E5960CUF8	Cherry	4 pieces/2lbs	\$38.70
<b>E010E5 - 1/2"W x .313"TH x 96"L</b>			
E010E5960UF2	Red Oak	10 pieces/3lbs	\$15.71
E010E5960UF8	Red Oak	4 pieces/2lbs	\$18.07
E010E5960MUF2	Maple	10 pieces/3lbs	\$18.69
E010E5960MUF8	Maple	4 pieces/2lbs	\$21.47
E010E5960CUF2	Cherry	10 pieces/3lbs	\$21.74
E010E5960CUF8	Cherry	4 pieces/2lbs	\$25.00
<b>E024D2 - 1/2"W x .313"TH x 96"L</b>			
E024D2960UF2	Red Oak	10 pieces/3lbs	\$15.43
E024D2960UF8	Red Oak	4 pieces/2lbs	\$17.72
E024D2960MUF2	Maple	10 pieces/3lbs	\$18.35
E024D2960MUF8	Maple	4 pieces/2lbs	\$21.12
E024D2960CUF2	Cherry	10 pieces/3lbs	\$21.29
E024D2960CUF8	Cherry	4 pieces/2lbs	\$24.48

### Embossed Mouldings - Unfinished (Cont.)

PART #	SPECIES QTY/ WT	CARTON	SUG. RETAIL PRICE EACH
<b>E023E4 - 3/4"W x 1/2"TH x 96"L</b>			
E023E4960UF8	Red Oak	4 pieces/2lbs	\$26.01
E023E4960MUF8	Maple	4 pieces/2lbs	\$32.84
E023E4960CUF8	Cherry	4 pieces/2lbs	\$39.85
<b>E029F1 - 3/4"W x .313"TH x 96"L</b>			
E029F1960UF8	Red Oak	4 pieces/2lbs	\$21.43
E029F1960MUF8	Maple	4 pieces/2lbs	\$26.25
E029F1960CUF8	Cherry	4 pieces/2lbs	\$31.18
<b>E039E2 - 1"W x .309"TH x 96"L</b>			
E039E2960UF8	Red Oak	4 pieces/2lbs	\$18.03
E039E2960MUF8	Maple	4 pieces/2lbs	\$22.16
E039E2960CUF8	Cherry	4 pieces/2lbs	\$26.39
<b>E359P2 - 3/4"W x .280"TH x 96"L</b>			
E359P2960UF8	Red Oak	4 pieces/2lbs	\$18.03
E359P2960MUF8	Maple	4 pieces/2lbs	\$22.16
E359P2960CUF8	Cherry	4 pieces/2lbs	\$26.39





# HARDWOOD MOULDINGS & CABINETY TRIMS

## RAISED PANEL VALANCES

### Solid Wood Raised Panel Valances

- Raised Panel or Flat Panel
- Our exclusive 4.5" stiles allow for trimming, accommodating widths from 25" to 60"
- Available in Red Oak, Maple, Hickory, Cherry and Alder
- 3/4" overall thickness

### Raised Panel Valances

PART #	SPECIES	CARTON QTY/ WT	SUG. RETAIL PRICE EACH
<b>60" W x 10-1/2" H</b>			
V1785OUF1	Red Oak	1 piece/16lbs	\$393.40
V1785MUF1	Maple	1 piece/16lbs	\$475.52
V1785HUF1	Hickory	1 piece/16lbs	\$397.08
V1785CUF1	Cherry	1 piece/16lbs	\$574.57
V1785QUF1	Alder	1 piece/16lbs	\$454.30
<b>54" W x 10-1/2" H</b>			
V1784OUF1	Red Oak	1 piece/14lbs	\$354.01
V1784MUF1	Maple	1 piece/14lbs	\$427.98
V1784HUF1	Hickory	1 piece/14lbs	\$357.37
V1784CUF1	Cherry	1 piece/14lbs	\$517.10
V1784QUF1	Alder	1 piece/14lbs	\$408.45
<b>48" W x 10-1/2" H</b>			
V1783OUF1	Red Oak	1 piece/12lbs	\$314.71
V1783MUF1	Maple	1 piece/12lbs	\$380.43
V1783HUF1	Hickory	1 piece/12lbs	\$317.66
V1783CUF1	Cherry	1 piece/12lbs	\$459.67
V1783QUF1	Alder	1 piece/12lbs	\$363.09
<b>42" W x 10-1/2" H</b>			
V1782OUF1	Red Oak	1 piece/10lbs	\$240.92
V1782MUF1	Maple	1 piece/10lbs	\$332.85
V1782HUF1	Hickory	1 piece/10lbs	\$277.95
V1782CUF1	Cherry	1 piece/10lbs	\$379.11
V1782QUF1	Alder	1 piece/10lbs	\$317.70
<b>36" W x 10-1/2" H</b>			
V1781OUF1	Red Oak	1 piece/8lbs	\$235.99
V1781MUF1	Maple	1 piece/8lbs	\$285.31
V1781HUF1	Hickory	1 piece/8lbs	\$238.25
V1781CUF1	Cherry	1 piece/8lbs	\$324.95
V1781QUF1	Alder	1 piece/8lbs	\$272.23
<b>30" W x 10-1/2" H</b>			
V1780OUF1	Red Oak	1 piece/6lbs	\$196.67
V1780MUF1	Maple	1 piece/6lbs	\$237.73
V1780HUF1	Hickory	1 piece/6lbs	\$198.54
V1780CUF1	Cherry	1 piece/6lbs	\$270.85
V1780QUF1	Alder	1 piece/6lbs	\$226.94



60W x 10-1/2"H



54W x 10-1/2"H



48W x 10-1/2"H



42W x 10-1/2"H



36W x 10-1/2"H



30W x 10-1/2"H

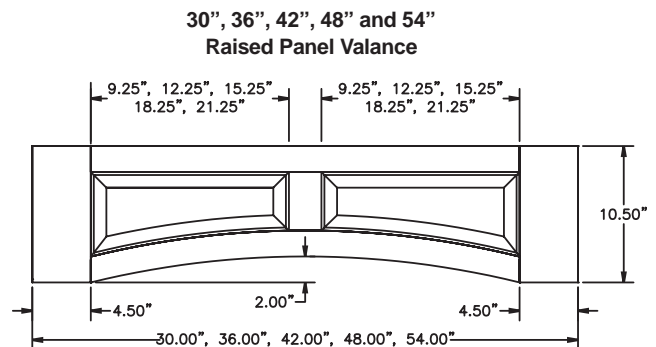
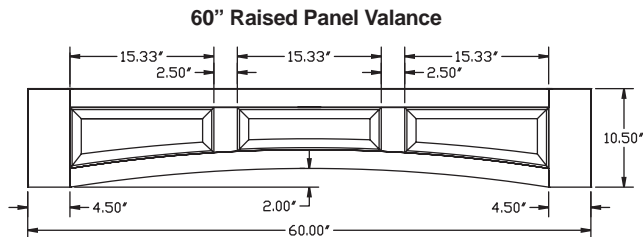

# HARDWOOD MOULDINGS & CABINETY TRIMS

## FLAT PANEL VALANCES



### Solid Wood Flat Panel Valances

- Flat Panel or Raised Panel
- Our exclusive 4.5" stiles allow for trimming, accommodating widths from 25" to 60"
- Available in Red Oak, Maple, Hickory, Cherry and Alder
- 3/4" overall thickness

### Flat Panel Valances

PART #	SPECIES	CARTON QTY/ WT	SUG. RETAIL PRICE EACH
<b>60"W x 10-1/2"H</b>			
V1795OUF1	Red Oak	1 piece/16lbs	\$317.32
V1795MUF1	Maple	1 piece/16lbs	\$399.68
V1795HUF1	Hickory	1 piece/16lbs	\$317.32
V1795CUF1	Cherry	1 piece/16lbs	\$465.74
V1795QUF1	Alder	1 piece/16lbs	\$379.53
<b>54"W x 10-1/2"H</b>			
V1794OUF1	Red Oak	1 piece/14lbs	\$285.58
V1794MUF1	Maple	1 piece/14lbs	\$359.69
V1794HUF1	Hickory	1 piece/14lbs	\$285.58
V1794CUF1	Cherry	1 piece/14lbs	\$419.20
V1794QUF1	Alder	1 piece/14lbs	\$341.59
<b>48"W x 10-1/2"H</b>			
V1793OUF1	Red Oak	1 piece/12lbs	\$253.85
V1793MUF1	Maple	1 piece/12lbs	\$319.74
V1793HUF1	Hickory	1 piece/12lbs	\$253.85
V1793CUF1	Cherry	1 piece/12lbs	\$372.63
V1793QUF1	Alder	1 piece/12lbs	\$303.62
<b>42"W x 10-1/2"H</b>			
V1792OUF1	Red Oak	1 piece/10lbs	\$221.95
V1792MUF1	Maple	1 piece/10lbs	\$279.76
V1792HUF1	Hickory	1 piece/10lbs	\$221.95
V1792CUF1	Cherry	1 piece/10lbs	\$326.02
V1792QUF1	Alder	1 piece/10lbs	\$265.64
<b>36"W x 10-1/2"H</b>			
V1791OUF1	Red Oak	1 piece/8lbs	\$190.39
V1791MUF1	Maple	1 piece/8lbs	\$239.81
V1791HUF1	Hickory	1 piece/8lbs	\$190.39
V1791CUF1	Cherry	1 piece/8lbs	\$279.45
V1791QUF1	Alder	1 piece/8lbs	\$227.67
<b>30"W x 10-1/2"H</b>			
V1790OUF1	Red Oak	1 piece/6lbs	\$158.66
V1790MUF1	Maple	1 piece/6lbs	\$199.79
V1790HUF1	Hickory	1 piece/6lbs	\$158.66
V1790CUF1	Cherry	1 piece/6lbs	\$232.87
V1790QUF1	Alder	1 piece/6lbs	\$189.77



60W x 10-1/2"H



54W x 10-1/2"H



48W x 10-1/2"H



42W x 10-1/2"H



36W x 10-1/2"H



30W x 10-1/2"H

30", 36", 42", 48" and 54"  
Flat Panel Valance

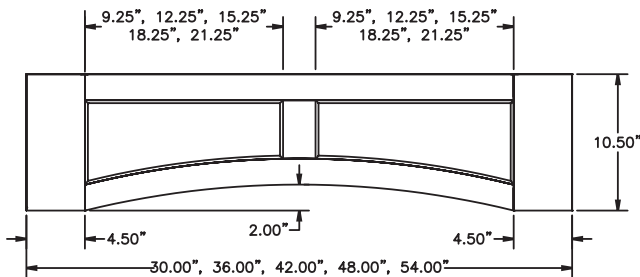

60" Flat Panel Valance

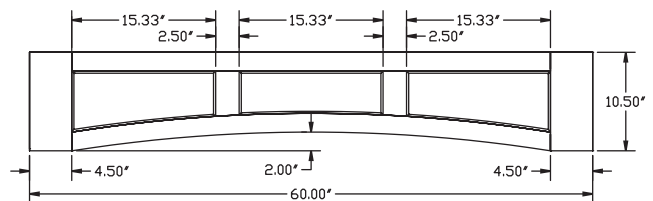





Bamboo - 611



Rope - 627



Beaded - 672

### Cabinet Door Stile Mouldings

- Choose from 3 patterns and 4 species
- Designed for simple mitreing and assembly
- Inside detail is already embossed on the moulding
- Add the outside edge detail desired

### Cabinet Door Stile Mouldings

PART #	SPECIES	CARTON QTY/ WT	SUG. RETAIL PRICE EACH
<b>96"L Moulding with Bamboo Pattern - 611</b>			
M61181OUF2	Red Oak	4 pieces/20lbs	\$45.78
M61181MUF2	Maple	4 pieces/20lbs	\$53.51
M61181CUF2	Cherry	4 pieces/20lbs	\$60.10
M61181QUF2	Alder	4 pieces/20lbs	\$66.72
<b>96"L Moulding with Rope Pattern - 627</b>			
M62781OUF2	Red Oak	4 pieces/20lbs	\$45.78
M62781MUF2	Maple	4 pieces/20lbs	\$53.51
M62781CUF2	Cherry	4 pieces/20lbs	\$60.10
M62781QUF2	Alder	4 pieces/20lbs	\$66.72
<b>96"L Moulding with Beaded Pattern - 672</b>			
M62782OUF2	Red Oak	4 pieces/20lbs	\$45.78
M62782MUF2	Maple	4 pieces/20lbs	\$53.51
M62782CUF2	Cherry	4 pieces/20lbs	\$60.10
M62782QUF2	Alder	4 pieces/20lbs	\$66.72



No More Applied Mouldings for Mitred Doors!

Simply select a pattern, trim and fit the mouldings together to make a door frame!

Bamboo Pattern

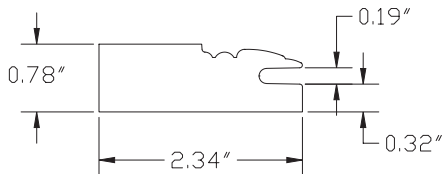

Rope and Beaded Patterns

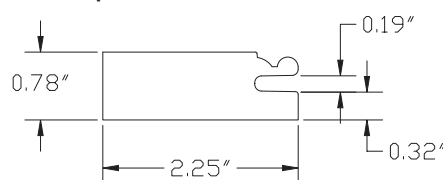

# HARDWOOD MOULDINGS & CABINETRY TRIMS

## BEADED & FLUTED FILLERS

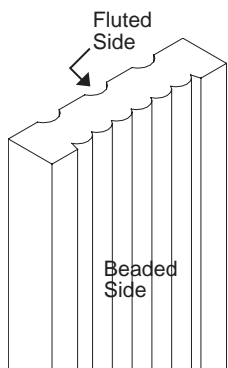

Beaded/Fluted Filler



Fluted Side



Beaded Side

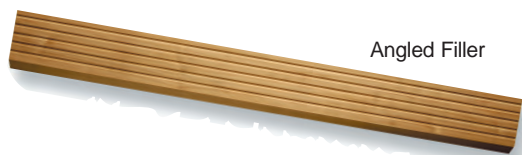

Angled Filler

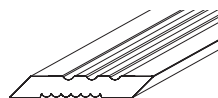

Angled Beaded/Fluted Filler

4-1/4" across face

Patent Nos. 5,794,399,  
5,692,354, DES 403,449

### Angled Beaded/Fluted Filler

- Same design as other fillers
- Angled versions are ideal for kitchen sink or any bump-out applications

### Angled Beaded/Fluted Filler - Unfinished

PART #	SPECIES	CARTON QTY/ WT	SUG. RETAIL PRICE EACH
<b>5"W x 42"L x 3/4"TH</b>			
M3994OUF2	Red Oak	2 pieces/9lbs	\$52.57
M3994MUF2	Maple	2 pieces/9lbs	\$69.91
M3994HUF2	Hickory	2 pieces/9lbs	\$54.48
M3994CUF2	Cherry	2 pieces/9lbs	\$88.43

### Beaded/Fluted Fillers

- Simply the best reversible filler moulding on the market
- Designed for either beaded or fluted applications, one moulding makes it simple and economical
- Moulded from our high quality lumber
- Offered with beaded/fluted rosettes for a completely finished look
- Four wood species, three lengths and two widths
- Angled version also available (below, left)

### Beaded/Fluted Fillers - Unfinished

PART #	SPECIES	CARTON QTY/ WT	SUG. RETAIL PRICE EACH
<b>3"W x 31-1/2"L x 3/4"TH</b>			
M4311OUF2	Red Oak	2 pieces/5lbs	\$23.24
M4311MUF2	Maple	2 pieces/5lbs	\$28.09
M4311HUF2	Hickory	2 pieces/5lbs	\$23.58
M4311CUF2	Cherry	2 pieces/5lbs	\$35.06
<b>3"W x 48"L x 3/4"TH</b>			
M4312OUF2	Red Oak	2 pieces/7lbs	\$37.42
M4312MUF2	Maple	2 pieces/7lbs	\$50.94
M4312HUF2	Hickory	2 pieces/7lbs	\$37.97
M4312CUF2	Cherry	2 pieces/7lbs	\$56.60
<b>3"W x 96"L x 3/4"TH</b>			
M4318OUF2	Red Oak	2 pieces/7lbs	\$68.11
M4318MUF2	Maple	2 pieces/7lbs	\$86.00
M4318HUF2	Hickory	2 pieces/7lbs	\$74.14
M4318CUF2	Cherry	2 pieces/7lbs	\$112.88
M4318OUF2	Alder	2 pieces/7lbs	\$73.45
<b>6"W x 96"L x 3/4"TH</b>			
M3868OUF2	Red Oak	2 pieces/18lbs	\$140.94
M3868MUF2	Maple	2 pieces/18lbs	\$169.82
M3868HUF2	Hickory	2 pieces/18lbs	\$155.88
M3868CUF2	Cherry	2 pieces/18lbs	\$194.86

Add our famous beaded fluted fillers/caps or Column Concepts for the ultimate in design, form and function.



# HARDWOOD MOULDINGS & CABINETRY TRIMS

BEADED & FLUTED CAPS

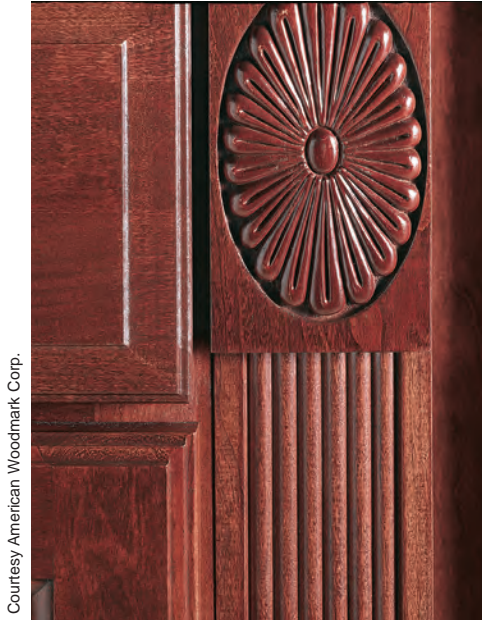

Courtesy American Woodmark Corp.



Courtesy American Woodmark Corp.

## Beaded/Fluted Caps - Unfinished

PART # FOR BEADED FIT	PART # FOR FLUTED FIT	SPECIES	CARTON QTY/WT	SUG. RETAIL PRICE EACH
<b>3" x 3" Pyramid Cap</b>				
R5510OUF2	R5520OUF2	Red Oak	4 pieces/1lb	\$10.68
R5510MUF2	R5520MUF2	Maple	4 pieces/1lb	\$12.28
R5510HUF2	R5520HUF2	Hickory	4 pieces/1lb	\$10.89
R5510CUF2	R5520CUF2	Cherry	4 pieces/1lb	\$13.98
<b>3" x 5-1/2" Cap with Installed Oval Daisy Appliqués</b>				
R43001OUF2	R43401OUF2	Red Oak	4 pieces/1lb	\$17.86
R43001MUF2	R43401MUF2	Maple	4 pieces/1lb	\$18.03
R43001HUF2	R43401HUF2	Hickory	4 pieces/1lb	\$18.83
R43001CUF2	R43401CUF2	Cherry	4 pieces/1lb	\$22.58
<b>3" x 4" Plain Cap, Cove Edge Plinth</b>				
R8187OUF2	R8140OUF2	Red Oak	4 pieces/1lb	\$6.80
R8187MUF2	R8140MUF2	Maple	4 pieces/1lb	\$7.49
R8187HUF2	R8140HUF2	Hickory	4 pieces/1lb	\$7.53
R8187CUF2	R8140CUF2	Cherry	4 pieces/1lb	\$9.99
<b>3" x 3" Rosette, Cove Edge</b>				
R8171OUF2	R8111OUF2	Red Oak	6 pieces/1lb	\$11.58
R8171MUF2	R8111MUF2	Maple	6 pieces/1lb	\$12.73
R8171HUF2	R8111HUF2	Hickory	6 pieces/1lb	\$11.76
R8171CUF2	R8111CUF2	Cherry	6 pieces/1lb	\$13.21
R8171OUF2	R8111OUF2	Alder	6 pieces/1lb	\$13.00
<b>3" x 3" Rosette, w/out Edge</b>				
R8185OUF2	R8125OUF2	Red Oak	6 pieces/1lb	\$9.02
R8185MUF2	R8125MUF2	Maple	6 pieces/1lb	\$9.81
R8185HUF2	R8125HUF2	Hickory	6 pieces/1lb	\$9.12
R8185CUF2	R8125CUF2	Cherry	6 pieces/1lb	\$11.93
<b>3" x 12" Plain, w/out Edge</b>				
R8191OUF2	R8151OUF2	Red Oak	6 pieces/3lbs	\$10.79
R8191MUF2	R8151MUF2	Maple	6 pieces/3lbs	\$11.96
R8191HUF2	R8151HUF2	Hickory	6 pieces/3lbs	\$10.92
R8191CUF2	R8151CUF2	Cherry	6 pieces/3lbs	\$14.53
<b>6" x 6" Rosette, Cove Edge</b>				
R3871OUF2	R8211OUF2	Red Oak	4 pieces/3lbs	\$23.06
R3871MUF2	R8211MUF2	Maple	4 pieces/3lbs	\$26.36
R3871HUF2	R8211CUF2	Hickory	4 pieces/3lbs	\$23.41
R3871CUF2	R8211HUF2	Cherry	4 pieces/3lbs	\$26.81
<b>6" x 8" Plain, Cove Edge</b>				
N/A	R8216OUF2	Red Oak	4 pieces/3lbs	\$21.33
N/A	R8216MUF2	Maple	4 pieces/3lbs	\$25.63
N/A	R8216HUF2	Hickory	4 pieces/3lbs	\$21.71
N/A	R8216CUF2	Cherry	4 pieces/3lbs	\$25.59

## Beaded/Fluted Caps, Acanthus Design, Carved Rosettes - Unfinished

PART #	SPECIES	CARTON QTY/ WT	SUG. RETAIL PRICE EACH
<b>3"W x 3"H x 1/2"TH Carved Rosette Cap, Acanthus, Beaded Fit</b>			
R9A0100OUF2	Red Oak	2 pieces/1lb	\$30.38
R9A0100MUF2	Maple	2 pieces/1lb	\$30.38
R9A0100CUF2	Cherry	2 pieces/1lb	\$36.86
<b>3"W x 3"H x 1/2"TH Carved Rosette Cap, Acanthus, Fluted Fit</b>			
R9A0101OUF2	Red Oak	2 pieces/1lb	\$30.38
R9A0101MUF2	Maple	2 pieces/1lb	\$30.38



R9A0100/101

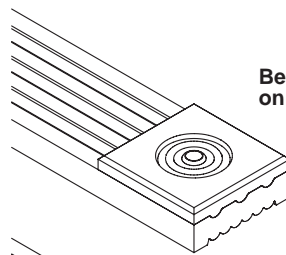

Beaded Cap on Fluted Filler

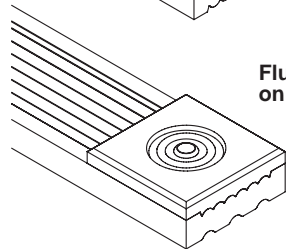

Fluted Cap on Beaded Filler

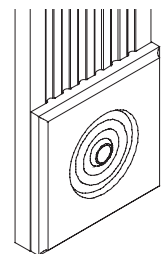

Beaded Filler with Fluted Rosette  
Patent Nos.  
5,794,399,  
5,692,354, DES 403,449

# INTERIOR CABINET ACCESSORIES

## KITCHENMATE BLIND CORNER CADDY & TRAY ROLL-OUT



### KitchenMATE™ Blind Corner Caddy, Maple

- Designed for those hard-to-reach areas in a blind corner cabinet
- This swing-out pantry features heavy duty hardware, 15mm prefinished maple storage bin and our professional grade rollout shelf kit
- Perfect for bulk storage, occasional-use items or countertop appliances
- Features premounted  8405 slides for easy installation
- Designed for 15" or larger openings
- Accessible from both sides
- Includes two shelf roll-out kit and all hardware
- Reversible piano hinge allows for left or right applications

### KitchenMate Blind Corner Caddy

PART #	CARTON QTY/ WT	SUG. RETAIL PRICE EACH
P0650MNL1	1 kit/45lbs	\$492.93

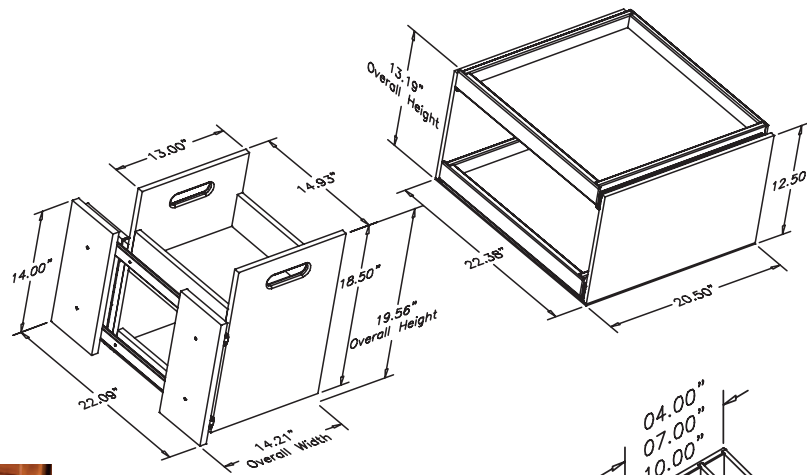

### KitchenMATE™ Tray Roll-Out, Maple

- Organizer designed for 9", 12" or 15" cabinets
- Provides lots of space for those hard to store and hard to reach pans, trays or serving platters
- Constructed from prefinished plywood with  8405 slides
- Partitions are removable for ultimate flexibility

### KitchenMate Tray Roll-Out

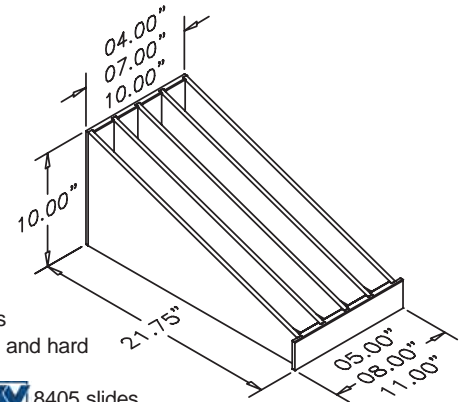

PART #	CARTON QTY/ WT	SUG. RETAIL PRICE EACH
<b>Rollout for 9" Base Cabinet – 1 Divider</b>		
T3194MNL1	1 piece/10lbs	\$90.10
<b>Rollout for 12" Base Cabinet – 2 Dividers</b>		
T3195MNL1	1 piece/12lbs	\$103.80
<b>Rollout for 15" Base Cabinet – 3 Dividers</b>		
T3196MNL1	1 piece/14lbs	\$121.38





KitchenMate™ is an Omega National Products exclusive product family. KitchenMate encompasses any product with a drawer slide or in/out convenience movement. The collection is highlighted by our Base, Upper and Corner Cabinet Pullouts.



### EVO

#### KitchenMATE™ Tall Pull-Out Wood Pantry

- Powered by the **Fuller** 771 ECS Heavy-Duty Slide with Easy Close and 250 lb capacity
- Designed to be trimmed or used at full height.
- Pre-finished Maple featuring adjustable shelves with Platinum Series™ Powdercoat rails
- Simply attach the door of your choice
- 8.5", 11.5" and 14.5" widths; all 21.15" deep
- Supplied 59.5" high and trimmable (Note: add 5.5" to accommodate supplied hardware)
- 3 way adjustable slide
- Shipped R.T.A.

#### Tall Pull-Out Wood Pantry

PART #	WIDTH	SUG. RETAIL PRICE EACH
P0450MNL1	8.5" wide	\$892.94
P0451MNL1	11.5" wide	\$926.02
P0452MNL1	14.5" wide	\$978.93

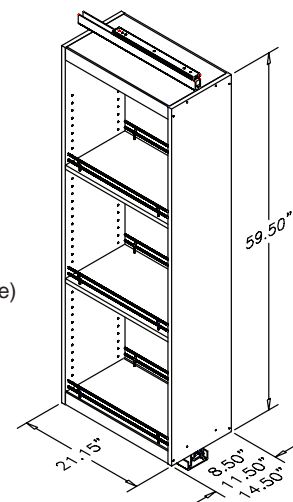

# INTERIOR CABINET ACCESSORIES

## TRAY ORGANIZERS



### Tra-Sta Organizer, Maple

- The perfect storage solution for cookie sheets, baking trays and muffin pans
- Four prefinished Maple veneer dividers slide in grooved and predrilled top and bottom rails
- Designed to be fastened in multiple locations to accept a variety of pots, pans or lids
- Easily trimmable to fit any size cabinet

### Tra-Sta Organizer

PART #	DESCRIPTION	CARTON QTY/ WT	SUG. RETAIL PRICE EACH
TS2424	Includes 4 Finished Dividers 3/16" Thick and 8 Drilled Rails	1 set/16lbs	\$169.93



**Tra-Sta Dividers** - 3/16" thick:  
 W: 23-3/4"  
 H: 23-3/4"

**Rails:**  
 W: 3/4"  
 L: 24"

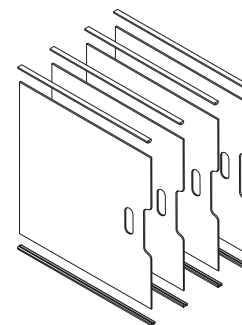

### Tra-Sta Deep Drawer Kit, Maple

- Modular and adjustable organizer, allows for organization of pots, pans, lids or plates, bowls and dishes
- Design segments for any size storage or any size deep drawer
- Features 3 prefinished 11" x 24" maple dividers and 6 predrilled mounting rails
- Easily trimmed for various drawer depths

### Tra-Sta Deep Drawer Kit

PART #	CARTON QTY/ WT	SUG. RETAIL PRICE EACH
C0480MNL1	1 kit/4lbs	\$82.16

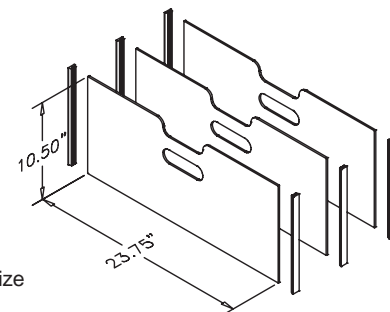



# INTERIOR CABINET ACCESSORIES

## UNIVERSAL DRAWER INSERT SET



### Universal Drawer Insert Set

Features (6) assembled pieces and (1) trimmable filler per set.

Maple and Birch construction.

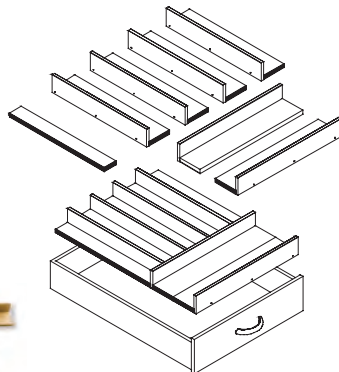

### Universal Drawer Insert Set

- Patented and one of the most versatile and economical systems on the market today
- Constructed of maple hardwood and plywood, this kit is completely modular
- It utilizes the entire drawer and can be assembled in any configuration for flatware, cooking utensils, or any kitchen organization solution
- Durable UV coating

### Universal Drawer Insert Set Clear Catalyzed Finish

PART #	DESCRIPTION	CARTON QTY/ WT	SUG. RETAIL PRICE EACH
C0491MNL1	19-3/4" L x 2-15/16" W x 2" H	1 Set/7lbs	\$67.28
C0495MNL1	60" L x 2-15/16" W x 2" H	1 Set/21lbs	\$190.70

Patent No. 6,695,419



# INTERIOR CABINET ACCESSORIES

## SPICE ORGANIZERS



### Spice Drawer Insert

- Designed for storage of all types of spice jars
- Produced from Baltic Birch plywood finished with a durable UV coating
- Each insert is easily trimmed to desired size
- Boxed individually
- Insert angle is 33°

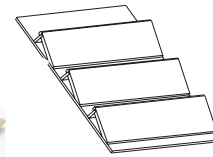

### Spice Drawer Insert

PART #	SIZE	CARTON QTY/ WT	SUG. RETAIL PRICE EACH
S9510DNL1	10" x 19-1/2"	1 carton/3lbs	\$51.46
S9513DNL1	13" x 19-1/2"	1 carton/3lbs	\$56.80
S9516DNL1	16" x 19-1/2"	1 carton/5lbs	\$64.30
S9519DNL1	19" x 19-1/2"	1 carton/5lbs	\$65.86
S9522DNL1	22" x 19-1/2"	1 carton/6lbs	\$78.90
S9560DNL1	60" x 19-1/2"	1 carton/6lbs	\$212.93

### Spice Insert Dimensions

Slant: 33°  
 W: 10", 13", 16",  
 19", 22" or 60"  
 H: 2"  
 D: 19-1/2"

All inserts easily trimmed to desired size.



Adjustable Spice Rack Shown Painted White

### Adjustable Spice Rack

- The simple and effective spice storage solution
- Simply attach to the back of any cabinet door for ease and convenience
- Two sizes to choose
- Manufactured from solid maple

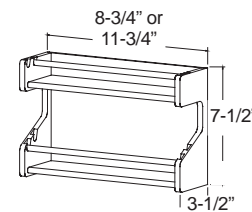

### Adjustable Spice Rack - Clear Finish

PART #	DESCRIPTION	CARTON QTY/ WT	SUG. RETAIL PRICE EACH
<b>Maple</b>			
S9400MNL2	8-3/4" Length	1 piece/3lbs	\$55.32
S9410MNL2	11-3/4" Length	1 piece/3lbs	\$57.22

### Adjustable Spice Rack Dimensions

W: 8-3/4" / 11-3/4"  
 H: 7-1/2"  
 D: 3-1/2"

### 10" Select Spice Susan, Maple

- 10" diameter and designed for spice storage
- Perfect for 12" deep cabinets
- Available individually with a 4" bearing attached with non-slip feet
- Ideal for spices, but designed for many storage applications
- Individual Susans can be taken with you to your work or grill area
- 1" lip, plywood core

### 10" Select Spice Susan

PART #	CARTON QTY/ WT	SUG. RETAIL PRICE EACH
<b>10" Spice Susan with Bearing Attached</b>		
T7210MNL1	1 piece/3lbs	\$33.73

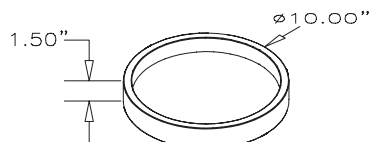





# EXTERIOR CABINET ACCESSORIES

## STEMWARE RACKS



Courtesy Canyon Creek Cabinetry



Courtesy Canyon Creek Cabinetry

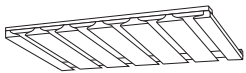

L: 18"/30"/36"  
W: 12"



### Stemware Rack

- Designed to display beautiful and valuable stemware collection
- Accommodates most stemware styles
- Boxed individually



### Stemware Moulding

- Solid wood, fully sanded and ready to finish
- 62" lengths in both profiles allow custom installation for residential or commercial applications

## Stemware Rack — Solid Wood

PART #	SPECIES QTY/ WT	CARTON	SUG. RETAIL PRICE EACH
<b>18" Stemware Rack - 4 Rows</b>			
S9600UF1	Red Oak	1 piece/3lbs	\$62.49
S9600MUF1	Maple	1 piece/3lbs	\$64.40
S9600HUF1	Hickory	1 piece/3lbs	\$66.27
S9600CUF1	Cherry	1 piece/3lbs	\$96.58
S9600QUF1	Alder	1 piece/3lbs	\$64.40
<b>30" Stemware Rack - 7 Rows</b>			
S9620UF1	Red Oak	1 piece/4lbs	\$87.11
S9620MUF1	Maple	1 piece/4lbs	\$99.74
S9620HUF1	Hickory	1 piece/4lbs	\$101.75
S9620CUF1	Cherry	1 piece/4lbs	\$132.58
S9620QUF1	Alder	1 piece/4lbs	\$102.13
<b>36" Stemware Rack - 8 Rows</b>			
S9630UF1	Red Oak	1 piece/5lbs	\$110.04
S9630MUF1	Maple	1 piece/5lbs	\$111.84
S9630HUF1	Hickory	1 piece/5lbs	\$117.46
S9630CUF1	Cherry	1 piece/5lbs	\$143.95
S9630QUF1	Alder	1 piece/5lbs	\$120.13

## Stemware Rack Mouldings

PART #	SPECIES	CARTON QTY/ WT	SUG. RETAIL PRICE EACH
<b>Stemware Rack "L" Moulding 62"</b>			
M4600UF2	Red Oak	12 pieces/17lbs	\$18.93
M4600MUF2	Maple	12 pieces/17lbs	\$25.56
M4600CUF2	Cherry	12 pieces/17lbs	\$30.31
M4600HUF2	Hickory	12 pieces/17lbs	\$20.81
M4600QUF2	Alder	12 pieces/17lbs	\$29.82
<b>Stemware Rack "T" Moulding 62"</b>			
M4640UF2	Red Oak	12 pieces/27lbs	\$30.31
M4640MUF2	Maple	12 pieces/27lbs	\$37.87
M4640CUF2	Cherry	12 pieces/27lbs	\$58.71
M4640HUF2	Hickory	12 carton/27lbs	\$32.18
M4640QUF2	Alder	12 carton/27lbs	\$44.77

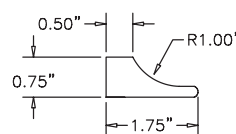

"L" Moulding

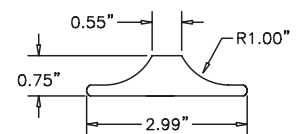

"T" Moulding

Length of both profiles: 62"L



# EXTERIOR CABINET ACCESSORIES

## WNE RACKS - INVERTED & SQUARED

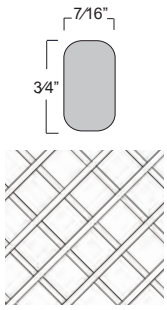

**Inverted**

### 4" x 4" openings

- 2430 – 18 full bottle openings
- 1736 – 14 full bottle openings
- 2443 – 28 full bottle openings
- 1729 – 11 full bottle openings

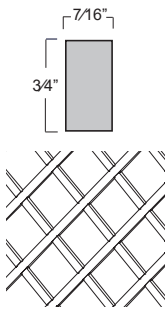

**Squared**

### 3-3/4" x 3-3/4" openings

- 2329 – 18 full bottle openings
- 1736 – 14 full bottle openings
- 2342 – 28 full bottle openings
- 1729 – 11 full bottle openings

Custom sizes available with minimums. Please inquire.



### Inverted Wine Racks

- Panels are produced from sturdy mouldings 3/4" thick x 7/16" wide with radiused edges
- Glued and mechanically fastened at joints
- Bottle openings are 4"x4"
- Easily cut to desired size
- Boxed two pieces per carton

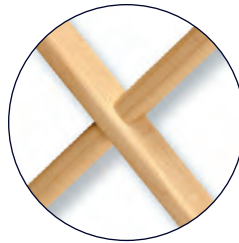

### Squared Wine Racks

- Panels are produced from sturdy mouldings 3/4" wide x 7/16" thick with square edges
- Glued and mechanically fastened at joints
- Bottle openings are 3-3/4" x 3-3/4"
- Easily cut to desired size
- Boxed two pieces per carton



## Wine Rack Lattice Panels — Inverted

PART #	SPECIES	CARTON QTY/ WT	SUG. RETAIL PRICE EACH
<b>Inverted Wine Racks - 17" x 29"</b>			
WRL1729RO	Red Oak	Pair/5lbs	\$78.03
WRL1729MA	Maple	Pair/5lbs	\$83.61
WRL1729HI	Hickory	Pair/5lbs	\$78.03
WRL1729CH	Cherry	Pair/5lbs	\$102.20
WRL1729AL	Alder	Pair/5lbs	\$104.04
<b>Inverted Wine Racks - 17" x 36"</b>			
WRL1736RO	Red Oak	Pair/6lbs	\$105.91
WRL1736MA	Maple	Pair/6lbs	\$113.33
WRL1736HI	Hickory	Pair/6lbs	\$105.91
WRL1736CH	Cherry	Pair/6lbs	\$137.50
WRL1736AL	Alder	Pair/6lbs	\$143.05
<b>Inverted Wine Racks - 24" x 30"</b>			
WRL2430RO	Red Oak	Pair/7lbs	\$111.49
WRL2430MA	Maple	Pair/7lbs	\$120.75
WRL2430HI	Hickory	Pair/7lbs	\$111.49
WRL2430CH	Cherry	Pair/7lbs	\$146.80
WRL2430AL	Alder	Pair/7lbs	\$152.35
<b>Inverted Wine Racks - 24" x 43"</b>			
WRL2443RO	Red Oak	Pair/9lbs	\$161.64
WRL2443MA	Maple	Pair/9lbs	\$169.06
WRL2443HI	Hickory	Pair/9lbs	\$161.64
WRL2443CH	Cherry	Pair/9lbs	\$206.24
WRL2443AL	Alder	Pair/9lbs	\$222.95

## Wine Rack Lattice Panels — Squared

PART #	SPECIES	CARTON QTY/ WT	SUG. RETAIL PRICE EACH
<b>Squared Wine Racks - 17" x 29"</b>			
L3080OUF9	Red Oak	Pair/5lbs	\$96.76
L3080MUF9	Maple	Pair/5lbs	\$104.56
L3080HUF9	Hickory	Pair/5lbs	\$98.18
L3080CUF9	Cherry	Pair/5lbs	\$122.45
L3080QUF9	Alder	Pair/5lbs	\$101.61
<b>Squared Wine Racks - 17" x 36"</b>			
L3060OUF9	Red Oak	Pair/6lbs	\$118.85
L3060MUF9	Maple	Pair/6lbs	\$128.45
L3060HUF9	Hickory	Pair/6lbs	\$120.65
L3060CUF9	Cherry	Pair/6lbs	\$157.79
<b>Squared Wine Racks - 23" x 29"</b>			
L3040OUF9	Red Oak	Pair/7lbs	\$135.01
L3040MUF9	Maple	Pair/7lbs	\$145.93
L3040HUF9	Hickory	Pair/7lbs	\$137.09
L3040CUF9	Cherry	Pair/7lbs	\$178.84
<b>Squared Wine Racks - 23" x 42"</b>			
L3020OUF9	Red Oak	Pair/9lbs	\$168.71
L3020MUF9	Maple	Pair/9lbs	\$182.38
L3020HUF9	Hickory	Pair/9lbs	\$171.28
L3020CUF9	Cherry	Pair/9lbs	\$215.05
L3020QUF9	Alder	Pair/9lbs	\$194.69



# EXTERIOR CABINET ACCESSORIES

## WINE RACKS - PREMIUM & DELUXE

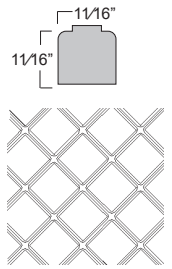

### Premium

#### 4-1/4" x 4-1/4" openings

- 2430 – 18 full bottle openings
- 1736 – 14 full bottle openings
- 2443 – 28 full bottle openings
- 1729 – 11 full bottle openings

### Premium Wine Racks

- Premium routed panels produced from 11/16" x 11/16" hardwood mouldings
- Glued and mechanically fastened half-lap joints
- Bottle openings are 4-1/4" x 4-1/4".
- All front piece openings are routed for a custom look, back piece unrouted
- Easily cut to desired size
- Boxed two pieces per carton



### Deluxe Wine Racks

- Panels are produced from sturdy mouldings 3/4" wide x 7/16" thick with square edges
- Glued and mechanically fastened at joints
- Bottle openings are 3-3/4" x 3-3/4"
- Routed Face for a custom look
- Easily cut to desired size
- Boxed two pieces per carton

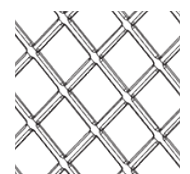
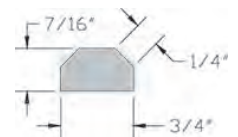

### Deluxe

#### 3-3/4" x 3-3/4" openings

- 2329 – 18 full bottle openings
- 1736 – 14 full bottle openings
- 2342 – 28 full bottle openings
- 1729 – 11 full bottle openings

Custom sizes available with minimums. Please inquire.

## Wine Rack Lattice Panels — Premium

PART #	SPECIES	CARTON QTY/ WT	SUG. RETAIL PRICE EACH
<b>Premium Wine Racks - 17" x 29"</b>			
WRLR1729RO	Red Oak	Pair/6lbs	\$131.26
WRLR1729MA	Maple	Pair/6lbs	\$139.20
WRLR1729HI	Hickory	Pair/6lbs	\$143.19
WRLR1729CH	Cherry	Pair/6lbs	\$171.04
WRLR1729AL	Alder	Pair/6lbs	\$178.95
<b>Premium Wine Racks - 17" x 36"</b>			
WRLR1736RO	Red Oak	Pair/8lbs	\$147.18
WRLR1736MA	Maple	Pair/8lbs	\$157.10
WRLR1736HI	Hickory	Pair/8lbs	\$161.09
WRLR1736CH	Cherry	Pair/8lbs	\$188.93
WRLR1736AL	Alder	Pair/8lbs	\$210.71
<b>Premium Wine Racks - 24" x 30"</b>			
WRLR2430RO	Red Oak	Pair/9lbs	\$151.13
WRLR2430MA	Maple	Pair/9lbs	\$167.05
WRLR2430HI	Hickory	Pair/9lbs	\$171.04
WRLR2430CH	Cherry	Pair/9lbs	\$202.84
WRLR2430AL	Alder	Pair/9lbs	\$234.57
<b>Premium Wine Racks - 24" x 43"</b>			
WRLR2443RO	Red Oak	Pair/11lbs	\$216.78
WRLR2443MA	Maple	Pair/11lbs	\$234.67
WRLR2443HI	Hickory	Pair/11lbs	\$216.78
WRLR2443CH	Cherry	Pair/11lbs	\$310.24
WRLR2443AL	Alder	Pair/11lbs	\$333.96

## Wine Rack Lattice Panels — Deluxe

PART #	SPECIES	CARTON QTY/ WT	SUG. RETAIL PRICE EACH
<b>Deluxe Wine Racks - 17" x 29"</b>			
L3380OUF9	Red Oak	Pair/5lbs	\$117.91
L3380MUF9	Maple	Pair/5lbs	\$127.52
L3380HUF9	Hickory	Pair/5lbs	\$119.71
L3380CUF9	Cherry	Pair/5lbs	\$143.95
L3380QUF9	Alder	Pair/5lbs	\$126.41
<b>Deluxe Wine Racks - 17" x 36"</b>			
L3360OUF9	Red Oak	Pair/6lbs	\$144.20
L3360MUF9	Maple	Pair/6lbs	\$155.85
L3360HUF9	Hickory	Pair/6lbs	\$146.38
L3360CUF9	Cherry	Pair/6lbs	\$187.06
L3360QUF9	Alder	Pair/6lbs	\$144.20
<b>Deluxe Wine Racks - 23" x 29"</b>			
L3340OUF9	Red Oak	Pair/7lbs	\$165.73
L3340MUF9	Maple	Pair/7lbs	\$179.08
L3340HUF9	Hickory	Pair/7lbs	\$168.23
L3340CUF9	Cherry	Pair/7lbs	\$218.90
L3340QUF9	Alder	Pair/7lbs	\$177.52
<b>Deluxe Wine Racks - 23" x 42"</b>			
L3320OUF9	Red Oak	Pair/9lbs	\$206.62
L3320MUF9	Maple	Pair/9lbs	\$223.27
L3320HUF9	Hickory	Pair/9lbs	\$209.67
L3320CUF9	Cherry	Pair/9lbs	\$269.91
L3320QUF9	Alder	Pair/9lbs	\$250.73

# EXTERIOR CABINET ACCESSORIES

## WNE RACKS - BULK PACKS

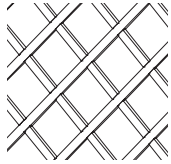
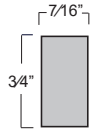

### Squared

#### 4" x 4" openings

- 2329 - 18 full bottle openings
- 1736 - 14 full bottle openings
- 2342 - 28 full bottle openings
- 1729 - 11 full bottle openings

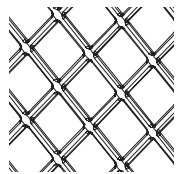
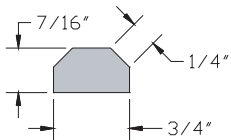

### Deluxe

#### 3-3/4" x 3-3/4" openings

- 2329 - 18 full bottle openings
- 1736 - 14 full bottle openings
- 2342 - 28 full bottle openings
- 1729 - 11 full bottle openings

Custom sizes available with minimums.

Please inquire.

### Squared Wine Racks (Bulk Pack)

- Panels are produced from sturdy mouldings 3/4" wide x 7/16" thick with square edges
- Glued and mechanically fastened at joints
- Bottle openings are 3-3/4" x 3-3/4"
- Easily cut to desired size



### Deluxe Wine Racks (Bulk Pack)

- Panels are produced from sturdy mouldings 3/4" wide x 7/16" thick with square edges
- Glued and mechanically fastened at joints
- Bottle openings are 3-3/4" x 3-3/4"
- Routed Face for a custom look
- Easily cut to desired size



### Squared Wine Racks (Bulk Pack)

PART #	SPECIES	CARTON QTY/ WT	SUG. RETAIL PRICE EACH
<b>Squared Wine Racks (Bulk Pack) - 17" x 29"</b>			
L3080OUF2	Red Oak	10 pieces/25lbs	\$44.49
L3080MUF2	Maple	10 pieces/25lbs	\$48.10
L3080HUF2	Hickory	10 pieces/25lbs	\$45.29
L3080CUF2	Cherry	10 pieces/25lbs	\$55.21
L3080OUF2	Alder	10 pieces/25lbs	\$45.98
<b>Squared Wine Racks (Bulk Pack) - 17" x 36"</b>			
L3060OUF2	Red Oak	10 pieces/30lbs	\$55.45
L3060MUF2	Maple	10 pieces/30lbs	\$59.93
L3060HUF2	Hickory	10 pieces/30lbs	\$56.32
L3060CUF2	Cherry	10 pieces/30lbs	\$72.03
<b>Squared Wine Racks (Bulk Pack) - 23" x 29"</b>			
L3040OUF2	Red Oak	10 pieces/35lbs	\$61.94
L3040MUF2	Maple	10 pieces/35lbs	\$66.93
L3040HUF2	Hickory	10 pieces/35lbs	\$62.80
L3040CUF2	Cherry	10 pieces/35lbs	\$81.81
<b>Squared Wine Racks (Bulk Pack) - 23" x 42"</b>			
L3020OUF2	Red Oak	10 pieces/45lbs	\$80.21
L3020MUF2	Maple	10 pieces/45lbs	\$86.70
L3020HUF2	Hickory	10 pieces/45lbs	\$81.39
L3020CUF2	Cherry	10 pieces/45lbs	\$106.36
L3020OUF2	Alder	10 pieces/45lbs	\$87.43

### Deluxe Wine Racks (Bulk Pack)

PART #	SPECIES	CARTON QTY/ WT	SUG. RETAIL PRICE EACH
<b>Deluxe Wine Racks (Bulk Pack) - 17" x 29"</b>			
L3380OUF2	Red Oak	10 pieces/25lbs	\$55.59
L3380MUF2	Maple	10 pieces/25lbs	\$60.10
L3380HUF2	Hickory	10 pieces/25lbs	\$56.49
L3380CUF2	Cherry	10 pieces/25lbs	\$68.94
L3380OUF2	Alder	10 pieces/25lbs	\$58.40
<b>Deluxe Wine Racks (Bulk Pack) - 17" x 36"</b>			
L3360OUF2	Red Oak	10 pieces/30lbs	\$67.66
L3360MUF2	Maple	10 pieces/30lbs	\$73.07
L3360HUF2	Hickory	10 pieces/30lbs	\$68.67
L3360CUF2	Cherry	10 pieces/30lbs	\$86.63
<b>Deluxe Wine Racks (Bulk Pack) - 23" x 29"</b>			
L3340OUF2	Red Oak	10 pieces/35lbs	\$77.99
L3340MUF2	Maple	10 pieces/35lbs	\$84.24
L3340HUF2	Hickory	10 pieces/35lbs	\$79.17
L3340CUF2	Cherry	10 pieces/35lbs	\$95.47
<b>Deluxe Wine Racks (Bulk Pack) - 23" x 42"</b>			
L3320OUF2	Red Oak	10 pieces/45lbs	\$97.76
L3320MUF2	Maple	10 pieces/45lbs	\$105.56
L3320HUF2	Hickory	10 pieces/45lbs	\$99.22
L3320CUF2	Cherry	10 pieces/45lbs	\$126.48
L3320OUF2	Alder	10 pieces/45lbs	\$116.45





# EXTERIOR CABINET ACCESSORIES

## SONOMA SERIES WINE RACKS



### Sonoma Series Wine Rack

- Our new Sonoma Series Wine Rack features a square design and flush fit
- Manufactured from 3/4" x 7/16" hardwood mouldings, the Sonoma Series is available in the four standard sizes
- Openings are 3-3/4"
- Available in Red Oak, Maple, Hickory, Cherry and Alder
- Boxed per pair

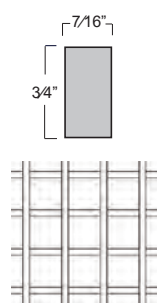

### Sonoma Series Wine Rack

PART #	SPECIES	CARTON QTY/ WT	SUG. RETAIL PRICE EACH
<b>Sonoma Series Wine Rack - 17" x 29"</b>			
L3280OUF9	Red Oak	1 pair/6lbs	\$121.72
L3280MUF9	Maple	1 pair/6lbs	\$123.84
L3280HUF9	Hickory	1 pair/6lbs	\$144.09
L3280CUF9	Cherry	1 pair/6lbs	\$150.27
L3280QUF9	Alder	1 pair/6lbs	\$146.45
<b>Sonoma Series Wine Rack - 17" x 36"</b>			
L3260OUF9	Red Oak	1 pair/7lbs	\$133.90
L3260MUF9	Maple	1 pair/7lbs	\$135.84
L3260HUF9	Hickory	1 pair/7lbs	\$155.68
L3260CUF9	Cherry	1 pair/7lbs	\$158.14
L3260QUF9	Alder	1 pair/7lbs	\$153.59
<b>Sonoma Series Wine Rack - 24" x 30"</b>			
L3240OUF9	Red Oak	1 pair/8lbs	\$157.17
L3240MUF9	Maple	1 pair/8lbs	\$163.79
L3240HUF9	Hickory	1 pair/8lbs	\$180.58
L3240CUF9	Cherry	1 pair/8lbs	\$185.74
L3240QUF9	Alder	1 pair/8lbs	\$182.17
<b>Sonoma Series Wine Rack - 24" x 43"</b>			
L3220OUF9	Red Oak	1 pair/10lbs	\$225.03
L3220MUF9	Maple	1 pair/10lbs	\$233.98
L3220HUF9	Hickory	1 pair/10lbs	\$257.18
L3220CUF9	Cherry	1 pair/10lbs	\$266.09
L3220QUF9	Alder	1 pair/10lbs	\$260.75

### Sonoma Series 3-3/4" x 3-3/4" openings

- 1729 – 18 full bottle openings
- 1736 – 21 full bottle openings
- 2430 – 24 full bottle openings
- 2443 – 28 full bottle openings

# EXTERIOR CABINET ACCESSORIES

## WNE BOTTLE RACKS



Courtesy Wellborn Cabinet Co.



### Wine Bottle Rack

- Solid wood wine bottle rack
- Great alternative to our wine bottle lattice panels, the 48" bottle rack holds eleven wine bottles and is easily trimmed for installation in any size cabinet or shelf
- Stack multiple units for a custom display
- Sanded and ready to finish
- Boxed per pair



### Wine Bottle Racks — Solid Wood

PART #	SPECIES	CARTON QTY/ WT	SUG. RETAIL PRICE EACH
<b>48" Wine Bottle Rack - (11 bottles)</b>			
S9200OUF1	Red Oak	Pair/4lbs	\$73.00
S9200MUF1	Maple	Pair/4lbs	\$80.18
S9200HUF1	Hickory	Pair/4lbs	\$74.07
S9200CUF1	Cherry	Pair/4lbs	\$102.23
<b>30" Wine Bottle Rack - (7 bottles)</b>			
S9210OUF1	Red Oak	Pair/3lbs	\$68.60
S9210MUF1	Maple	Pair/3lbs	\$74.98
S9210HUF1	Hickory	Pair/3lbs	\$65.89
S9210CUF1	Cherry	Pair/3lbs	\$73.97

### Wine Bottle Racks — Solid Wood

PART #	SPECIES	CARTON QTY/ WT	SUG. RETAIL PRICE EACH
<b>24" Wine Bottle Rack - (5 bottles)</b>			
S9220OUF1	Red Oak	Pair/2lbs	\$54.24
S9220MUF1	Maple	Pair/2lbs	\$61.31
S9220HUF1	Hickory	Pair/2lbs	\$59.61
S9220CUF1	Cherry	Pair/2lbs	\$66.10
<b>18" Wine Bottle Rack - (4 bottles)</b>			
S9230OUF1	Red Oak	Pair/2lbs	\$56.49
S9230MUF1	Maple	Pair/2lbs	\$60.38
S9230HUF1	Hickory	Pair/2lbs	\$54.83
S9230CUF1	Cherry	Pair/2lbs	\$59.79





# EXTERIOR CABINET ACCESSORIES

## PLATE & CHINA DISPLAY RACKS



Courtesy American Woodmark Corp.



Courtesy Canyon Creek Cabinetry



### Plate Display Rack - Ready-to-Assemble

- Same great design and craftsmanship as pre-assembled version
- Ready-to-assemble, perfectly suited for a variety of cabinet types and sizes
- Dowels spaced 2" on center
- Kit includes 2 top and bottom predrilled rails, and appropriate number of dowels
- Can be trimmed to any size
- Boxed per kit



### Plate Display Rack

- Pre-assembled plate display
- Designed for china or everyday ware
- Dowels are 3/8" diameter
- Center 3 dowels of assembled unit are removable for easy cleaning of the cabinet
- Dowels spaced 2" on center
- Assembled version packed 1 pair/box



Dowels can be removed for easy cleaning.

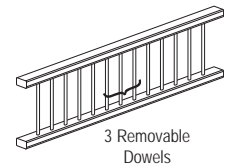

3 Removable Dowels

### Plate Display Rack - Ready-to-Assemble, Fluted

- Same great design and craftsmanship as pre-assembled version
- Ready-to-assemble version with intricately fluted dowels perfectly suited for a variety of cabinet types and sizes
- Dowels spaced 2" on center
- Kit includes 2 top and bottom predrilled rails and (32) 12" fluted dowels
- Can be trimmed to any size
- Boxed per kit

### Angled Plate Display Rack

- Ideal for a tasteful display of your plates
- Offers increased accessibility
- Installed dimensions are 10-9/16" deep by 8-1/2" wide

### Plate Display Rack

PART #	SPECIES/DIMS	CARTON QTY/ WT	SUG. RETAIL PRICE EACH
<b>30"/36" Plate Display Rack</b>			
NPD-30-RO	Red Oak	pair/4lbs	\$72.97
NPD-30-MA	Maple	pair/4lbs	\$74.98
NPD-30-HI	Hickory	pair/4lbs	\$77.02
NPD-30-CH	Cherry	pair/4lbs	\$111.49
NPD-36-RO	Red Oak	pair/5lbs	\$87.15
NPD-36-MA	Maple	pair/5lbs	\$89.20
NPD-36-HI	Hickory	pair/5lbs	\$91.21
NPD-36-CH	Cherry	pair/5lbs	\$131.75
<b>Angled Plate Rack for 24" Cabinet</b>			
P2201OUF2	Red Oak, 22-1/4"	pair/5lbs	\$122.38
P2201MUF2	Maple, 22-1/4"	pair/5lbs	\$123.67
P2201HUF2	Hickory, 22-1/4"	pair/5lbs	\$118.98
P2201CUF2	Cherry, 22-1/4"	pair/5lbs	\$158.76
<b>Angled Plate Rack for 30" Cabinet</b>			
P2202OUF2	Red Oak, 28-1/4"	pair/5lbs	\$133.83
P2202MUF2	Maple, 28-1/4"	pair/5lbs	\$135.11
P2202HUF2	Hickory, 28-1/4"	pair/5lbs	\$130.43
P2202CUF2	Cherry, 28-1/4"	pair/5lbs	\$170.21
<b>Angled Plate Rack for 36" Cabinet</b>			
P2203OUF2	Red Oak, 34-1/4"	pair/5lbs	\$145.27
P2203MUF2	Maple, 34-1/4"	pair/5lbs	\$146.55
P2203HUF2	Hickory, 34-1/4"	pair/5lbs	\$141.87
P2203CUF2	Cherry, 34-1/4"	pair/5lbs	\$181.65

**Plate Display Rack**  
H: 13-1/16"  
W: 30" and 36"

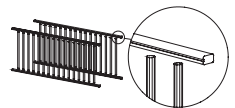

**RTA Plate Display Rack**  
Dowels:  
12-3/16" L  
Dowel diameter: 3/8"

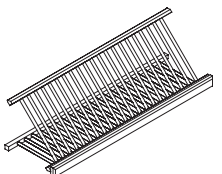

**Angled Plate Display Rack**

### Plate Display Rack - RTA

PART #	SPECIES	CARTON QTY/ WT	SUG. RETAIL PRICE EACH
<b>30" RTA Plate Display Rack</b>			
NPD-30-RTARO	Red Oak	4 pair/16lbs	\$58.78
NPD-30-RTAMA	Maple	4 pair/16lbs	\$58.78
NPD-30-RTAHI	Hickory	4 pair/16lbs	\$62.84
NPD-30-RTACH	Cherry	4 pair/16lbs	\$87.15
<b>36" RTA Plate Display Rack</b>			
NPD-36-RTARO	Red Oak	4 pair/20lbs	\$64.85
NPD-36-RTAMA	Maple	4 pair/20lbs	\$68.91
NPD-36-RTAHI	Hickory	4 pair/20lbs	\$70.95
NPD-36-RTACH	Cherry	4 pair/20lbs	\$101.33
<b>36" RTA Plate Display Rack - Fluted Dowels</b>			
P1100OUF2	Red Oak	6 pair/15lbs	\$74.01
P1100MUF2	Maple	6 pair/15lbs	\$81.98
P1100HUF2	Hickory	6 pair/15lbs	\$74.01
P1100CUF2	Cherry	6 pair/15lbs	\$84.79
P1100QUF2	Alder	6 pair/15lbs	\$76.50

# EXTERIOR CABINET ACCESSORIES

## CORNER APPLIANCE GARAGES

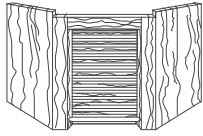

**National  
AG-100-C**

W: 17"  
H: 18-1/2"  
D: 11-7/8"  
Easily trimmable

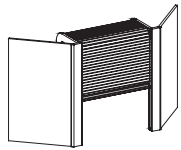

**Omega  
AO100**

W: 16-3/4"  
H: 18"  
D: 11-1/8"  
Easily trimmable



Courtesy Canyon Creek Cabinetry

### National Appliance Garage

- Solid wood or wood veneer tambour door mounted to solid wood face frame
- End panels are veneer faced and backed on 3/8" MDF, using plain-sliced veneer
- Doweled joints
- Spring Tension Track System (ST-2)
- Smooth, non-binding operation
- Prefabricated for simple installation
- Boxed individually



### Omega Appliance Garage

- Wood veneer tambour door
- End panels are veneer faced and backed on 3/8" MDF, using plain sliced veneer
- Finger-Lite track system
- Boxed individually



### National Appliance Garage — Corner

PART #	SPECIES	CARTON QTY/ WT	SUG. RETAIL PRICE EACH
<b>Solid Wood (SW-30) Door for 24" Corner</b>			
AG-100CSR	Red Oak	1 carton/9lbs	\$180.02
AG-100CSM	Maple	1 carton/9lbs	\$194.34
AG-100CSH	Hickory	1 carton/9lbs	\$198.43
AG-100CSC	Cherry	1 carton/9lbs	\$237.28
AG-100CSAL	Alder	1 carton/9lbs	\$237.28
<b>Veneer (V-3) Door for 24" Corner</b>			
AG-100CVR	Red Oak	1 carton/9lbs	\$151.38
AG-100CVM	Maple	1 carton/9lbs	\$161.61
AG-100CVH	Hickory	1 carton/9lbs	\$163.65
AG-100CVC	Cherry	1 carton/9lbs	\$177.97
AG-100CVAL	Alder	1 carton/9lbs	\$184.11

See Tambour Section for Tambour Door details.

### Omega Appliance Garage — Corner

PART #	SPECIES	CARTON QTY/ WT	SUG. RETAIL PRICE EACH
<b>Veneer (V-3) Door for 24" Corner</b>			
A0100MUF1	Maple	1 carton/10lbs	\$150.47
A0100OUF1	Red Oak	1 carton/10lbs	\$141.39
A0100HUF1	Hickory	1 carton/10lbs	\$152.28
A0100CUF1	Cherry	1 carton/10lbs	\$176.38
A0100QUF1	Alder	1 carton/10lbs	\$165.45

See Tambour Section for Tambour Door details.





# EXTERIOR CABINET ACCESSORIES

## APPLIANCE GARAGES

Courtesy American Woodmark Corp.

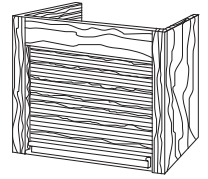

**National  
AG-100-S**

W: 18", 24" or 30"  
H: 18-1/2"  
D: 11-7/8"  
Easily trimmable.

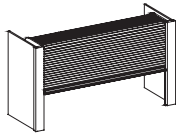

**Omega  
AO160**

W: 30"  
H: 18"  
D: 11-3/4"  
Easily trimmable.

See Tambour Section for Tambour Door details.

### National Appliance Garage - Straight

- Solid wood or wood veneer tambour door mounted to solid wood face frame
- End panels veneer faced and backed on 3/8" MDF, using plain-sliced veneer
- Doweled joints
- Spring Tension Track System (ST-2).
- Smooth, non-binding operation
- Prefabricated for simple installation
- Boxed individually



### Omega Appliance Garage - Straight

- Wood veneer tambour door
- End panels are veneer faced and backed on 3/8 MDF, using plain sliced veneer
- Finger-Lite track system
- Boxed individually



## National Appliance Garage — Straight

PART #	SPECIES	CARTON QTY/ WT	SUG. RETAIL PRICE EACH
<b>18" Straight Solid Wood (SW-30) Door</b>			
AG-100SSR-18	Red Oak	1 carton/9lbs	\$190.25
AG-100SSM-18	Maple	1 carton/9lbs	\$248.00
AG-100SSH-18	Hickory	1 carton/9lbs	\$198.43
AG-100SSC-18	Cherry	1 carton/9lbs	\$243.41
AG-100SSAL-18	Alder	1 carton/9lbs	\$245.46
<b>24" Straight Solid Wood (SW-30) Door</b>			
AG-100SSR-24	Red Oak	1 carton/10lbs	\$229.09
AG-100SSM-24	Maple	1 carton/10lbs	\$245.46
AG-100SSH-24	Hickory	1 carton/10lbs	\$237.28
AG-100SSC-24	Cherry	1 carton/10lbs	\$290.47
AG-100SSAL-24	Alder	1 carton/10lbs	\$302.75
<b>30" Straight Solid Wood (SW-30) Door</b>			
AG-100SSR-30	Red Oak	1 carton/12lbs	\$274.11
AG-100SSM-30	Maple	1 carton/12lbs	\$294.57
AG-100SSH-30	Hickory	1 carton/12lbs	\$302.75
AG-100SSC-30	Cherry	1 carton/12lbs	\$360.01
AG-100SSAL-30	Alder	1 carton/12lbs	\$364.10
<b>18" Straight Veneer (V-3) Door</b>			
AG-100SVR-18	Red Oak	1 carton/9lbs	\$158.52
AG-100SVM-18	Maple	1 carton/9lbs	\$171.84
AG-100SVH-18	Hickory	1 carton/9lbs	\$169.79
AG-100SVC-18	Cherry	1 carton/9lbs	\$188.20
AG-100SVAL-18	Alder	1 carton/9lbs	\$196.35
<b>24" Straight Veneer (V-3) Door</b>			
AG-100SVR-24	Red Oak	1 carton/10lbs	\$182.07
AG-100SVM-24	Maple	1 carton/10lbs	\$200.48
AG-100SVH-24	Hickory	1 carton/10lbs	\$202.53
AG-100SVC-24	Cherry	1 carton/10lbs	\$214.77
AG-100SVAL-24	Alder	1 carton/10lbs	\$222.95
<b>30" Straight Veneer (V-3) Door</b>			
AG-100SVR-30	Red Oak	1 carton/12lbs	\$200.48
AG-100SVM-30	Maple	1 carton/12lbs	\$208.67
AG-100SVH-30	Hickory	1 carton/12lbs	\$216.85
AG-100SVC-30	Cherry	1 carton/12lbs	\$237.28
AG-100SVAL-30	Alder	1 carton/12lbs	\$241.37

## Omega Appliance Garage — Straight Veneer Door

PART #	SPECIES	CARTON QTY/ WT	SUG. RETAIL PRICE EACH
<b>30" Straight Veneer (V-3) Door</b>			
A0160OUF1	Red Oak	1 piece/12lbs	\$200.13
A0160MUF1	Maple	1 piece/12lbs	\$217.34
A0160HUF1	Hickory	1 piece/12lbs	\$206.41
A0160CUF1	Cherry	1 piece/12lbs	\$221.84
A0160QUF1	Alder	1 piece/12lbs	\$216.12

# EXTERIOR CABINET ACCESSORIES

## APPLIANCE GARAGE TRACK SYSTEMS

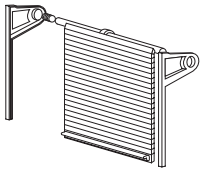

### Track System ST-2

(Frame Style Mounting)

Door Widths:  
15", 24", 30"  
Door Height: 18"  
Track Height: 18"

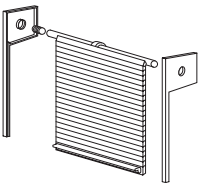

### Track System ST-3

(Frameless Style Mounting)

Door Widths:  
15", 24", 30"  
Door Height: 18"  
Track Height: 17-1/2"



### Tambour Door Kits for Appliance Garage Fabrication

- Includes quality tambour door with hand pull and spring tension tambour track system, packed together in a carton
- Track system consists of two PVC guide rails, wood dowel, donut(s), and tension spring
- ST-2 easily mounts to back of face frame and ST-3 (frameless) is designed to recess mount in end panel
- Easily trimmable

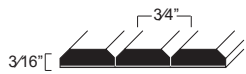

**SW-30**  
Solid Wood



**V-3**  
Wood Veneer

• Other wood species available – please inquire

• All track kits are available in almond or white

• Easily trimmable

### Tambour Door & ST-2 Track System - Face Frame Style

PART #	SPECIES	DOOR STYLE	CARTON QTY/ WT	SUG. RETAIL PRICE EACH
<b>15"SL x 18" - Face Frame Style</b>				
CO2-VRO-1	Red Oak	V-3	1 carton/3lbs	\$68.91
CO2-SRO-1	Red Oak	SW-30	1 carton/3lbs	\$99.29
CO2-VMA-1	Maple	V-3	1 carton/3lbs	\$72.97
CO2-SMA-1	Maple	SW-30	1 carton/3lbs	\$101.33
CO2-VHI-1	Hickory	V-3	1 carton/3lbs	\$77.02
CO2-SHI-1	Hickory	SW-30	1 carton/3lbs	\$105.39
CO2-VCH-1	Cherry	V-3	1 carton/3lbs	\$85.14
CO2-SCH-1	Cherry	SW-30	1 carton/3lbs	\$133.76
<b>24"SL x 18" - Face Frame Style</b>				
CO2-VRO-2	Red Oak	V-3	1 carton/4lbs	\$93.22
CO2-SRO-2	Red Oak	SW-30	1 carton/4lbs	\$133.76
CO2-VMA-2	Maple	V-3	1 carton/4lbs	\$97.28
CO2-SMA-2	Maple	SW-30	1 carton/4lbs	\$139.83
CO2-VHI-2	Hickory	V-3	1 carton/4lbs	\$101.33
CO2-SHI-2	Hickory	SW-30	1 carton/4lbs	\$143.88
CO2-VCH-2	Cherry	V-3	1 carton/4lbs	\$107.40
CO2-SCH-2	Cherry	SW-30	1 carton/4lbs	\$178.36
<b>30"SL x 18" - Face Frame Style</b>				
CO2-VRO-3	Red Oak	V-3	1 carton/5lbs	\$105.39
CO2-SRO-3	Red Oak	SW-30	1 carton/5lbs	\$158.07
CO2-VMA-3	Maple	V-3	1 carton/5lbs	\$111.46
CO2-SMA-3	Maple	SW-30	1 carton/5lbs	\$162.13
CO2-VHI-3	Hickory	V-3	1 carton/5lbs	\$119.57
CO2-SHI-3	Hickory	SW-30	1 carton/5lbs	\$174.30
CO2-VCH-3	Cherry	V-3	1 carton/5lbs	\$127.69
CO2-SCH-3	Cherry	SW-30	1 carton/5lbs	\$206.72

### Tambour Door & ST-3 Track System - Frameless Style

PART #	SPECIES	DOOR STYLE	CARTON QTY/ WT	SUG. RETAIL PRICE EACH
<b>15"SL x 18" - Frameless Style</b>				
CO3-VRO-1	Red Oak	V-3	1 carton/3lbs	\$68.91
CO3-SRO-1	Red Oak	SW-30	1 carton/3lbs	\$99.29
CO3-VMA-1	Maple	V-3	1 carton/3lbs	\$72.97
CO3-SMA-1	Maple	SW-30	1 carton/3lbs	\$101.33
CO3-VHI-1	Hickory	V-3	1 carton/3lbs	\$77.02
CO3-SHI-1	Hickory	SW-30	1 carton/3lbs	\$105.39
CO3-VCH-1	Cherry	V-3	1 carton/3lbs	\$85.14
CO3-SCH-1	Cherry	SW-30	1 carton/3lbs	\$133.76
<b>24"SL x 18" - Frameless Style</b>				
CO3-VRO-2	Red Oak	V-3	1 carton/4lbs	\$93.22
CO3-SRO-2	Red Oak	SW-30	1 carton/4lbs	\$133.76
CO3-VMA-2	Maple	V-3	1 carton/4lbs	\$97.28
CO3-SMA-2	Maple	SW-30	1 carton/4lbs	\$139.83
CO3-VHI-2	Hickory	V-3	1 carton/4lbs	\$101.33
CO3-SHI-2	Hickory	SW-30	1 carton/4lbs	\$143.88
CO3-VCH-2	Cherry	V-3	1 carton/4lbs	\$107.40
CO3-SCH-2	Cherry	SW-30	1 carton/4lbs	\$178.36
<b>30"SL x 18" - Frameless Style</b>				
CO3-VRO-3	Red Oak	V-3	1 carton/5lbs	\$105.39
CO3-SRO-3	Red Oak	SW-30	1 carton/5lbs	\$158.07
CO3-VMA-3	Maple	V-3	1 carton/5lbs	\$111.46
CO3-SMA-3	Maple	SW-30	1 carton/5lbs	\$162.13
CO3-VHI-3	Hickory	V-3	1 carton/5lbs	\$119.57
CO3-SHI-3	Hickory	SW-30	1 carton/5lbs	\$174.30
CO3-VCH-3	Cherry	V-3	1 carton/5lbs	\$127.69
CO3-SCH-3	Cherry	SW-30	1 carton/5lbs	\$206.72



# EXTERIOR CABINET ACCESSORIES

## LATTICE DOOR INSERTS

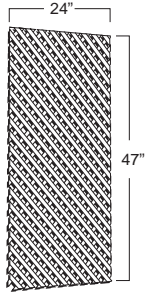

### Mini Diagonal Lattice Door Insert

Cell size: 1/2"  
Thickness: 5/32"



### Mini Diagonal Lattice Door Insert

PART #	SPECIES	CARTON QTY/ WT	SUG. RETAIL PRICE EACH
<b>48" x 24" x 5/32" Solid Wood</b>			
LATDS2448WO	White Oak	1 piece/4lbs	\$402.28
LATDS2448MA	Maple	1 piece/4lbs	\$442.16
LATDS2448BI	Birch	1 piece/4lbs	\$332.92
LATDS2448CH	Cherry	1 piece/4lbs	\$446.50
LATDS2448AL	Alder	1 piece/4lbs	\$326.68



### Mini Diagonal Lattice Door Insert

- Solid wood mini-lattice inserts ideal for cabinet door inserts, residential and commercial casework, wine cabinets, closet storage systems, entertainment centers and ceiling inserts
- 1/2" cell size
- Mouldings measure 7/16" wide x 5/32"
- Sanded and ready-to-finish
- Door frame not included

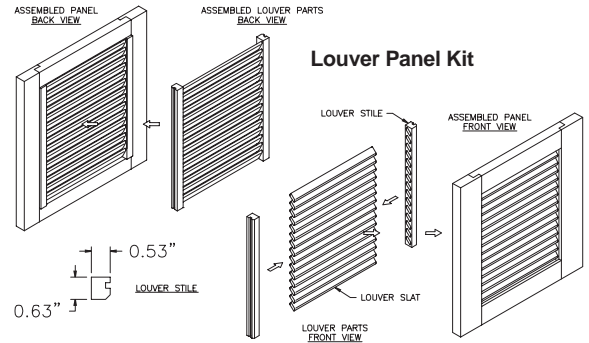

### Louver Panel Kit

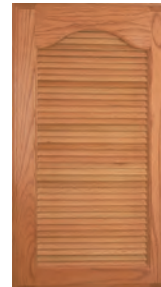

### Louver Panel Kit

- The classic way to achieve "southern" style architecture
- Beautiful and functional by allowing air transfer from either side
- Great for partition doors, pantries, or accent cabinets
- Includes: (36) 36" Moulded slats, (6) 36" Routed Side Stiles, (3-lefts, 3-rights)

### Louver Panel Kit, K.D. - Unfinished

PART #	SPECIES	CARTON QTY/ WT	SUG. RETAIL PRICE EACH
L1001OUF1	Red Oak	1 kit/7lbs	\$200.38
L1001MUF1	Maple	1 kit/7lbs	\$246.33
L1001HUF1	Hickory	1 kit/7lbs	\$278.75
L1001CUF1	Cherry	1 kit/7lbs	\$278.75



# EXTERIOR CABINET ACCESSORIES

## CORBELS & SUPPORT BRACKETS



### Signature Series Corbel Collection

- Hand carved by master artisans
- Offered with either a flat back or beaded/fluted design



### Signature Series - Scroll Corbels

PART #	SPECIES	CARTON QTY/ WT	SUG. RETAIL PRICE EACH
<b>3"W x 13"H x 9"D - Flat</b>			
CCS0103OUF1	Red Oak	1 piece/5lbs	\$151.76
CCS0103MUF1	Maple	1 piece/5lbs	\$159.52
CCS0103CUF1	Cherry	1 piece/5lbs	\$198.16
CCS0103RUF1	Rubberwood	1 piece/5lbs	\$114.68
CCS0103QUF1	Alder	1 piece/5lbs	\$144.13
<b>6"W x 9-1/2"H x 6-1/4"D - Flat</b>			
CCS0203OUF1	Red Oak	1 piece/4lbs	\$189.90
CCS0203MUF1	Maple	1 piece/4lbs	\$189.90
CCS0203CUF1	Cherry	1 piece/4lbs	\$236.27
<b>3"W x 5"H x 2"D - Fluted for Beaded Fit</b>			
CCS0801OUF1	Red Oak	1 piece/2lbs	\$88.43
CCS0801CUF1	Cherry	1 piece/2lbs	\$105.95

### Signature Series - Vineyard Corbels

PART #	SPECIES	CARTON QTY/WT	SUG. RETAIL PRICE EACH
<b>3"W x 13"H x 9"D - Flat</b>			
CCG0303OUF1	Red Oak	1 piece/5lbs	\$189.70
CCG0303MUF1	Maple	1 piece/5lbs	\$189.70
CCG0303CUF1	Cherry	1 piece/5lbs	\$236.10
CCG0303RUF1	Rubberwood	1 piece/5lbs	Inquire



2"W x 10"H x 8"D  
2"W x 8"H x 6"D

### Signature Series - Support Brackets

PART #	SPECIES	CARTON QTY/ WT	SUG. RETAIL PRICE EACH
<b>2"W x 10"H x 8"D - Support Brackets</b>			
S1101OUF2	Red Oak	2 pieces/3lbs	\$27.12
S1101MUF2	Maple	2 pieces/3lbs	\$28.19
S1101CUF2	Cherry	2 pieces/2lbs	\$33.19
S1101QUF2	Alder	2 pieces/2lbs	\$25.59
<b>2"W x 8"H x 6"D - Support Brackets</b>			
S1102OUF2	Red Oak	2 pieces/2lbs	\$26.01
S1102MUF2	Maple	2 pieces/2lbs	\$27.08
S1102HUF2	Hickory	2 pieces/2lbs	\$28.19
S1102CUF2	Cherry	2 pieces/2lbs	\$32.11
S1102QUF2	Alder	2 pieces/1lbs	\$24.48



# TAMBOUR DOORS, TRACK SYSTEMS & PANELS

## SOLID WOOD DECORATIVE TAMBOUR



### Solid Wood Decorative Tambour

PART #	SPECIES	WEIGHT	SUG. RETAIL PRICE EACH
<b>95"SL x 12" x 5/16", Half Round</b>			
SW-15-RO901	Red Oak	8lbs	\$223.06
SW-15-MA908	Maple	8lbs	\$309.79
SW-15-CH902	Cherry	8lbs	\$346.98
SW-15-PO901*	Poplar	8lbs	\$202.39
SW-15-MH901*	Mahogany*	8lbs	\$388.27
SW-15-WA901*	Walnut*	8lbs	\$408.90
<b>95"SL x 12" x 3/16", Flat</b>			
SW-30-RO901	Red Oak	8lbs	\$264.36
SW-30-MA901	Maple	8lbs	\$297.37
SW-30-CH901	Cherry	8lbs	\$371.73
SW-30-PO901*	Poplar	8lbs	\$198.26
SW-30-MH901*	Mahogany*	8lbs	\$392.40
SW-30-WA901*	Walnut*	8lbs	\$367.60
<b>95"SL x 12" x 5/16", Flat</b>			
SW-42-RO901	Red Oak	10lbs	\$305.66
SW-42-MA901	Maple	10lbs	\$351.09
SW-42-CH901	Cherry	10lbs	\$450.21
<b>95"SL x 12" x 1/4", Pencillane</b>			
SW-504-RO901	Red Oak*	8lbs	\$334.59
SW-504-MA901	Maple*	8lbs	\$392.40
SW-504-CH901	Cherry*	8lbs	\$516.31

Decorative tambours are not recommended for functional applications

\*May require additional lead time/minimum order quantity

\*Custom quote species

### Solid Wood Tambour Panels

- Designed for architectural applications, including wall covering, wainscoting or custom millwork projects.
- Individual solid hardwood slat mouldings bonded to a flexible backer
- Black cloth backer
- Other wood species available - please inquire

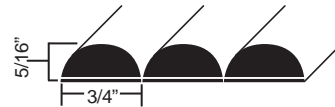

SW-15



SW-30



SW-42

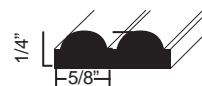

SW-504

# TAMBOUR DOORS, TRACK SYSTEMS & PANELS

## WOOD VENEER DECORATIVE TAMBOUR



### Wood Veneer Decorative Tambour

- Wood veneer bonded to medium density fiberboard or hardboard
- Bonded to flexible backer
- Brown paper backer
- Fire-Rated tambours are available

### Wood Veneer Decorative Tambour

PART #	SPECIES	WEIGHT	SUG. RETAIL PRICE EACH
<b>96"SL x 48", 1/2" Slats, Rotary Sliced</b>			
V100-801CG-8	Red Oak	16lbs	\$228.36
<b>96"SL x 48", 3/4" Slats, Rotary Sliced</b>			
V100-802CG-8	Red Oak	16lbs	\$228.36
<b>96"SL x 48", 1/2" Slats, Plain Sliced</b>			
V101-801	Red Oak	16lbs	\$296.47
V102-801	Birch	16lbs	\$327.34
V103-801	Walnut	16lbs	\$407.66
V107-801	Maple	16lbs	\$327.34
V108-801	Cherry	16lbs	\$370.58
<b>96"SL x 48", 3/4" Slats, Plain Sliced</b>			
V101-802	Red Oak	16lbs	\$296.47
V102-802	Birch	16lbs	\$327.34
V103-802	Walnut	16lbs	\$407.66
V107-802	Maple	16lbs	\$327.34
V108-802	Cherry	16lbs	\$370.58

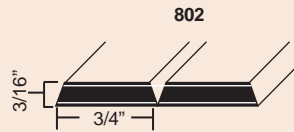
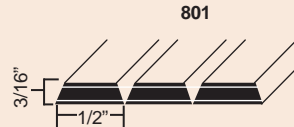

### Paint-Grade Hardboard

- Hardboard bonded to flexible backer
- Available in P-111 ready-to-finish

### Paintable Tambour

PART #	WEIGHT	SUG. RETAIL PRICE EACH
<b>P111-801</b>	16lbs	
96"SL x 48", 1/2" Slats, Paintgrade Hardboard		\$162.13
<b>P111-802</b>	16lbs	
96"SL x 48", 3/4" Slats, Paintgrade Hardboard		\$162.13



P111-801



P111-802





# TAMBOUR DOORS, TRACK SYSTEMS & PANELS

## WOOD VENEER TAMBOUR DOORS



**V-3**  
Wood Veneer



**SW-30**  
Solid Wood



**SW-15**  
Solid Wood



**SW-42**  
Solid Wood

### Wood Veneer Tambour Doors

- Wood veneer bonded to medium density fiberboard with a balance veneer
- Bonded to cloth backer for functional stability and performance
- Available standard in 5 wood species (other wood species available; please inquire)
- Sanded and ready to finish

For over 50 years,  
we have been  
manufacturing the  
finest tambour  
doors on the  
market.

### Wood Veneer Tambour Doors

PART #	SPECIES	WEIGHT	SUG. RETAIL PRICE EACH
<b>47-1/2" Slat Length x 24"W/1 Leadrail</b>			
V-3-RO505	Red Oak	6lbs	\$105.15
V-3-MA517	Maple	6lbs	\$113.57
V-3-HI510	Hickory	6lbs	\$117.77
V-3-CH513	Cherry	6lbs	\$117.77
V-3-AL502	Alder	6lbs	\$176.69
<b>47-1/2" Slat Length x 36"W/2 Leadrails</b>			
V-3-RO502	Red Oak	9lbs	\$141.18
V-3-MA501	Maple	9lbs	\$147.14
V-3-HI509	Hickory	9lbs	\$167.05
V-3-CH520	Cherry	9lbs	\$167.05
V-3-AL501	Alder	9lbs	\$238.63

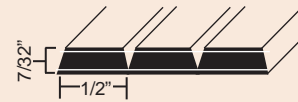

**V-3**  
Cloth backed tambour door  
30 degree v-groove

### Omega Wood Veneer Tambour Doors

- Unique look with flat cut veneer face
- Balanced construction
- Light brown core 7/32" thickness
- Available in 5 wood species (other wood species available; please inquire)
- Sanded and ready to finish

### Omega Wood Veneer Tambour Doors

PART #	SPECIES	CARTON QTY/ WT	SUG. RETAIL PRICE EACH
<b>Veneer, 47-3/4" Slat Length x 37" w/2 Leadrails, 3/16" TH</b>			
T0180OUF2	Red Oak	5 pieces/50lbs	\$156.61
T0180MUF2	Maple	5 pieces/50lbs	\$186.37
T0180HUF2	Hickory	5 pieces/50lbs	\$292.80
T0180CUF2	Cherry	5 pieces/50lbs	\$197.50
<b>Veneer, 96" Slat Length x 48", 3/16" TH</b>			
T0220OUF2	Red Oak	1 piece/26lbs	\$416.46
T0220MUF2	Maple	1 piece/26lbs	\$509.68
T0220HUF2	Hickory	1 piece/26lbs	\$649.54
T0220CUF2	Cherry	1 piece/26lbs	\$524.52

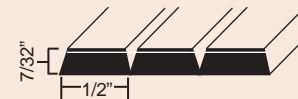

**Omega Tambour Door**  
Cloth backed tambour door  
30 degree v-groove



# TAMBOUR DOORS, TRACK SYSTEMS & PANELS

## SOLID WOOD TAMBOUR DOORS



### Solid Wood Tambour Doors

- Individual solid hardwood slat mouldings bonded to a cloth backer
- Simply the best tambour door on the market
- Available in 5 wood species
- Sanded and ready to finish

### Solid Wood Tambour Doors

PART #	SPECIES	WEIGHT	SUG. RETAIL PRICE EACH
<b>47" Slat Length x 24" w/1 Leadrail</b>			
SW-30-RO511	Red Oak	8lbs	\$220.91
SW-30-MA512	Maple	8lbs	\$249.27
SW-30-HI502	Hickory	8lbs	\$224.96
SW-30-CH503	Cherry	8lbs	\$318.18
SW-30-AL504	Alder	8lbs	\$239.15
<b>47" Slat Length x 36" w/2 Leadrails</b>			
SW-30-RO513	Red Oak	8lbs	\$338.34
SW-30-MA508	Maple	12lbs	\$368.85
SW-30-HI506	Hickory	12lbs	\$344.54
SW-30-CH514	Cherry	12lbs	\$453.95
SW-30-AL503	Alder	12lbs	\$364.79
<b>60" Slat Length x 36" w/2 Leadrails</b>			
SW-30-RO607	Red Oak	15lbs	\$456.00
SW-30-MA601	Maple	15lbs	\$494.49
SW-30-HI602	Hickory	15lbs	\$458.01
SW-30-CH605	Cherry	15lbs	\$628.25
SW-30-AL601	Alder	15lbs	\$486.38
<b>47" Slat Length x 24" w/1 Leadrail</b>			
SW-15-RO502	Red Oak	8lbs	\$243.21
SW-15-MA503	Maple	8lbs	\$273.58
SW-15-HI502	Hickory	8lbs	\$251.29
SW-15-CH507	Cherry	8lbs	\$287.77
SW-15-AL502	Alder	8lbs	\$287.77
<b>47" Slat Length x 36" w/2 Leadrails</b>			
SW-15-RO530	Red Oak	8lbs	\$360.73
SW-15-MA518	Maple	12lbs	\$397.22
SW-15-HI509	Hickory	12lbs	\$376.96
SW-15-CH509	Cherry	12lbs	\$427.60
SW-15-AL501	Alder	12lbs	\$429.64
<b>60" Slat Length x 36" w/2 Leadrails</b>			
SW-15-RO701	Red Oak	15lbs	\$478.30
SW-15-MA603	Maple	15lbs	\$512.73
SW-15-HI602	Hickory	15lbs	\$490.43
SW-15-CH610	Cherry	15lbs	\$575.57
SW-15-AL601	Alder	15lbs	\$571.51
<b>47" Slat Length x 24" w/1 Leadrail</b>			
SW-42-RO501	Red Oak	8lbs	\$256.34
SW-42-MA501	Maple	8lbs	\$304.00
SW-42-HI501	Hickory	8lbs	\$255.34
SW-42-CH501	Cherry	8lbs	\$372.91
SW-42-AL501	Alder	8lbs	\$295.88
<b>47" Slat Length x 36" w/2 Leadrails</b>			
SW-42-RO502	Red Oak	8lbs	\$385.08
SW-42-MA502	Maple	12lbs	\$458.01
SW-42-HI502	Hickory	12lbs	\$385.08
SW-42-CH502	Cherry	12lbs	\$559.34
SW-42-AL502	Alder	12lbs	\$445.84
<b>60" Slat Length x 36" w/2 Leadrails</b>			
SW-42-RO601	Red Oak	15lbs	\$486.38
SW-42-MA601	Maple	15lbs	\$575.67
SW-42-HI601	Hickory	15lbs	\$486.38
SW-42-CH601	Cherry	15lbs	\$705.27
SW-42-AL602	Alder	15lbs	\$689.18



SW-15 - Walnut



SW-42 - Maple

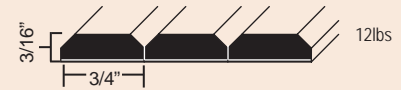

**SW-30**  
Cloth backed tambour door



**SW-15**  
Cloth backed tambour door

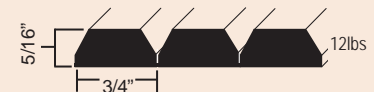

**SW-42**  
Cloth backed tambour door

Other wood species available including mahogany, walnut, white oak, poplar. Please inquire.  
Leadrails are 1-1/2"W x tambour thickness.





# TAMBOUR DOORS, TRACK SYSTEMS & PANELS

## PVC TRACK SYSTEMS

**Tambour Track Systems** are offered by Omega National Products for most any tambour application. Designed for vertical or horizontal uses, small or large spaces, standard profiles or custom, our tambour track offering is the broadest available.

### PVC (Flush Mount) Track System ST-21 Track and Spiral

- Spiral track system designed for flush mounting
- Accommodates almost any size tambour door of 3/16" thickness with 1/2" slats
- Holds up to 21" of tambour door
- Can be fastened with 3/8" staples or pan head type screws

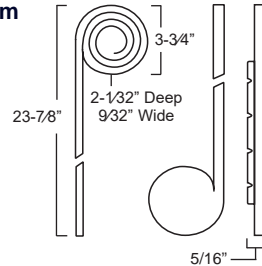

### PVC (Flush Mount) Track System C-51 Corner

- Designed for flush mounting
- Combine T-96 straight sections with C-51 corners to accommodate almost any size tambour door of 3/16" thickness
- Thicker tambours must be tenoned
- Can be fastened with 3/8" staples or pan head type screws

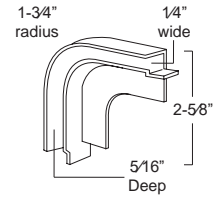

### PVC Track Systems - Flush Mounting

PART #	COLOR	CARTON QTY/ WT	SUG. RETAIL PRICE EACH
<b>Spiral Tambour Track (pair)</b>			
ST-21LR-BL	Black	10 pairs/10lbs	\$14.74
ST-21LR-BR	Brown	10 pairs/10lbs	\$14.74
ST-21LR-WH	White	10 pairs/10lbs	\$14.74
<b>Corner Tambour Flush Mount Track</b>			
C51-BL	Black	50 pieces/5lbs	\$2.39
C51-BR	Brown	50 pieces/5lbs	\$2.39
C51-WH	White	50 pieces/5lbs	\$2.39
<b>Straight Flush Mount Track</b>			
T96-BL	Black	30 pieces/20lbs	\$9.95
T96-BR	Brown	30 pieces/20lbs	\$9.95
T96-WH	White	30 pieces/20lbs	\$9.95

### PVC (Flush Mount) Track System T-96 Plastic Track

- Designed for flush mounting
- Combine T-96 straight sections with C-51 corners to accommodate almost any size tambour door of 3/16" thickness
- Thicker tambours must be tenoned
- Can be fastened with 3/8" staples or pan head type screws

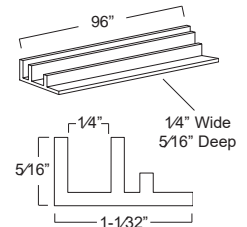

### PVC (Recessed Mount) Track System UT-24, PT-24, LT-22, ST-48 Track Profile

- A self-lubricating track system for most any tambour door style, thickness or size
- Rigid extruded PVC
- Easily cut to desired lengths
- Track can be recessed in routed 3/8" deep x 9/16" wide groove or stapled directly to end panels
- Smooth operation, no sticking
- All styles accept a maximum tambour thickness of 7/32"
- Thicker tambours must be tenoned

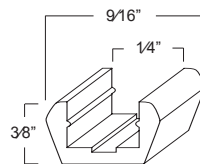

### PVC Track Systems - Recessed Mounting

PART #	COLOR	CARTON QTY/ WT	SUG. RETAIL PRICE EACH
<b>U-Shaped Flush Mount Track</b>			
UT-24-BR	Brown	30 pieces/15lbs	\$22.47
UT-24-WH	White	30 pieces/15lbs	\$22.47
<b>P-Shaped Flush Mount Track</b>			
PT-24-RL-BR	Brown	15 pairs/8lbs	\$37.63
PT-24-RL-WH	White	15 pairs/8lbs	\$37.63
<b>L-Shaped Flush Mount Track</b>			
LT-22-BR	Brown	30 pieces/15lbs	\$15.92
LT-22-WH	White	30 pieces/15lbs	\$15.92
<b>Straight Flush Mount Track</b>			
ST-48-BR	Brown	10 pieces/5lbs	\$13.87
ST-48-WH	White	10 pieces/5lbs	\$13.87

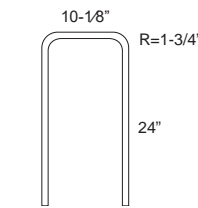

UT-24 U-Track

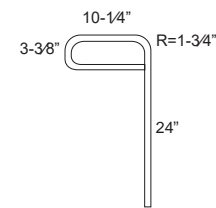

PT-24 P-Track

Custom sizes available

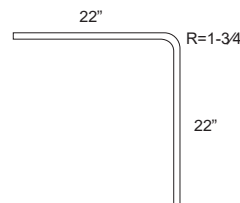

LT-22 L-Track



ST-48 Straight Track

Please inquire.



# TAMBOUR DOORS, TRACK SYSTEMS & PANELS

## TAMBOUR TRACK & FINGER-LITE TRACK SYSTEMS



### Face Frame Style (ST-2)

- System includes tension spring, wood dowel, donut(s) and plastic guide rails for Tambour Doors
- Controls Tambour Doors up to 36" wide x 19" high x .220" thick
- Dowels can be trimmed for narrower door widths
- Door is easily controlled from top to bottom, glides smoothly
- Easily stapled to back of face frame

### Frameless Mount Style (ST-3)

- System includes tension spring, wood dowel, donut(s) and plastic guide rails for Tambour Doors
- Controls Tambour Doors up to 36" wide x 19" high x .220" thick
- Dowels can be trimmed for narrower door widths
- Door is easily controlled from top to bottom, glides smoothly
- Can be recessed or flush mounted to end panels

## Spring Tension Track Systems - Face Frame Style

PART #	COLOR	CARTON QTY/ WT	SUG. RETAIL PRICE EACH
<b>16" x 17-1/2" Spring Tension Track</b>			
ST-2-16-AL	Almond	10 pairs/5lbs	\$20.84
ST-2-16-WH	White	10 pairs/5lbs	\$20.84
<b>24" x 17-1/2" Spring Tension Track</b>			
ST-2-24-AL	Almond	10 pairs/6lbs	\$24.62
ST-2-24-WH	White	10 pairs/6lbs	\$24.62
<b>30" x 17-1/2" Spring Tension Track</b>			
ST-2-30-AL	Almond	10 pairs/7lbs	\$26.53
ST-2-30-WH	White	10 pairs/7lbs	\$26.53
<b>36" x 17-1/2" Spring Tension Track</b>			
ST-2-36-AL	Almond	10 pairs/8lbs	\$28.40
ST-2-36-WH	White	10 pairs/8lbs	\$28.40

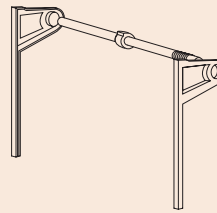

**ST-2**  
Face Frame Mount  
  
Approximate cabinet opening height: 16-1/2"

## Spring Tension Track Systems - Frameless Style

PART #	COLOR	CARTON QTY/ WT	SUG. RETAIL PRICE EACH
<b>16" x 18" Spring Tension Track</b>			
ST-3-16-AL	Almond	10 pairs/5lbs	\$24.62
ST-3-16-WH	White	10 pairs/5lbs	\$24.62
<b>24" x 18" Spring Tension Track</b>			
ST-3-24-AL	Almond	10 pairs/6lbs	\$26.53
ST-3-24-WH	White	10 pairs/6lbs	\$26.53
<b>30" x 18" Spring Tension Track</b>			
ST-3-30-AL	Almond	10 pairs/7lbs	\$28.40
ST-3-30-WH	White	10 pairs/7lbs	\$28.40
<b>36" x 18" Spring Tension Track</b>			
ST-3-36-AL	Almond	10 pairs/8lbs	\$30.31
ST-3-36-WH	White	10 pairs/8lbs	\$30.31

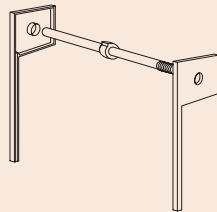

**ST-3**  
Frameless Mount  
  
Approximate cabinet opening height: 16-1/2"

### Finger-Lite™ Tambour Track System, Patented

- Available in Face Frame and Frameless styles
- Designed for tambour thicknesses up to 3/16"
- System includes spring, bushing, 2 spacer rails, fasteners and installation instructions

### Finger Lite™ Tambour Track System

PART #	DESCRIPTION	CARTON QTY/ WT	SUG. RETAIL PRICE EACH
T04019002-W01	Track, 18 1/4" Face Frame Style, Brown	25 pairs/13lbs	\$10.02
T04049002-W01	Track, 17 1/2" Length, Frameless, White	25 pairs/13lbs	\$10.02
T04029002-W01	Finger Lite™ Hardware Pack	25 sets/11lbs	\$14.53

Patent No. 4,947,937

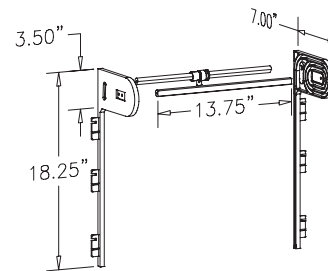



**Richelieu**

# R Richelieu



Omega National  
P R O D U C T S

Updated: July 2019



Distributed by:

