



— • DRAWER

4SDI Series

- Designed for 36" or smaller base cabinet drawers
- Trim-to-fit existing drawer
- Drop-in installation
- Natural maple construction with semi-gloss finish
- (1) rear compartment and up to (3) tiers
- Compatible with 4WD Wood Divider when using multiple inserts
- TSCA Title VI compliant



Wide Spice Drawer Insert



Wide Spice Drawer Insert

PRODUCT	DESCRIPTION		FINISH	SLP
4SDI-36-1	Drawer Insert	33-1/8" (841 mm) W x 19-3/4" (502 mm) D x 1-3/4" (44 mm) H	Maple	\$166.75

Drawer Solutions

4WUTCT Series

- Designed for 36" or smaller base cabinet drawers
- Trim-to-fit existing drawer
- Drop-in installation
- Natural maple construction with semi-gloss finish
- (1) adjustable compartments
- Up to (12) static compartments
- 2-7/8" H
- Compatible with 4WD Wood Divider when using multiple inserts
- TSCA Title VI compliant



Wide Combination Drawer Insert



Wide Combination Utensil/Cutlery Drawer Insert

PRODUCT	DESCRIPTION		FINISH	SLP
4WUTCT-36-1	Drawer Insert	33-1/8" (841 mm) W x 19-3/4" (502 mm) D x 2-7/8" (73 mm) H	Maple	\$172.55

Wide Utensil Drawer Insert



4WUT Series

- Designed for 36" or smaller base cabinet drawers
- Trim-to-fit existing drawer
- Drop-in installation
- Natural maple construction with semi-gloss finish
- (4) adjustable compartments
- Up to (11) large compartments
- Compatible with 4WD Wood Divider when using multiple inserts
- TSCA Title VI compliant



Wide Utensil Drawer Insert

PRODUCT	DESCRIPTION	DIMS	FINISH	PRICE
4WUT-36-1	Utensil Drawer Insert	33-1/8" (841 mm) W x 19-3/4" (502 mm) D x 2-7/8" (73 mm) H	Maple	\$172.55

Wide Combination Drawer Insert



4WUTKB Series

- Designed for 36" or smaller base cabinet drawers
- Trim-to-fit existing drawer
- Drop-in installation
- Natural maple construction with semi-gloss finish
- (2) adjustable compartments
- Up to (6) compartments
- (15) knife slots (4WUTKB)
- 2-7/8" H
- Compatible with 4WD Wood Divider when using multiple inserts
- TSCA Title VI compliant



Wide Combination Cutlery/Knife Drawer Insert

PRODUCT	DESCRIPTION	DIMS	FINISH	PRICE
4WUTKB-36-1	Drawer Insert	33-1/8" (841 mm) W x 19-3/4" (502 mm) D x 2-7/8" (73 mm) H	Maple	\$166.75



- Designed for 30" and 36" base cabinet drawers
- Complete drawer system, just add your drawer front
- Easy installation
- Natural maple construction with semi-gloss finish
- Full-extension, TANDEM, 110 lb. rated, concealed slides with BLUMOTION soft-close
- (3) drawer compartments
- Sliding top tray is designed for use with 4WCT, 4WUT and 4WKB inserts (sold separately)
- Mounts to cabinet drawer front, rear and sidewalls
- Figure 8 door mount brackets
- TSCA Title VI compliant

Drawer Solutions

4WTCDD-365C-1



4WTCDD-305C-1 & 4WTCDD-724FLSC-1
Tiered Deep Drawers
(30" version shown)



Top tier compatible with our trimmable inserts

Full Access Tiered Deep Drawer w/ BLUMOTION Soft-Close

PRODUCT	DESCRIPTION	DIMS	MCO	CAB	FINISH	SLP
4WTCDD-724FLSC-1	Tiered Deep Drawer	28-1/2" (724 mm) W x 22-3/16" (564 mm) D x 8" (203 mm) H	28-1/2" (724 mm)	FLB30	Maple	\$441.00
4WTCDD-876FLSC-1	Tiered Deep Drawer	34-1/2" (876 mm) W x 22-3/16" (564 mm) D x 8" (203 mm) H	34-1/2" (876 mm)	FLB36	Maple	\$482.55

Face Frame Tiered Deep Drawer, w/ BLUMOTION Soft-Close

4WTCDD-305C-1	Tiered Deep Drawer	27" (686 mm) W x 22-3/16" (564 mm) D x 8" (203 mm) H	27" (686 mm)	FFB30	Maple	\$428.20
4WTCDD-365C-1	Tiered Deep Drawer	33" (838 mm) W x 22-3/16" (564 mm) D x 8" (203 mm) H	33" (838 mm)	FFB36	Maple	\$470.75

Cut-Out Cutting Board Drawer

4WCCB Series



- Designed for 18" cabinet drawers
- Natural maple construction with semi-gloss finish
- Removable, universal cut-out cutting board
- Removable, funnel insert
- Full-extension, TANDEM, 110 lb. rated, concealed slides with BLUMOTION soft-close
- Door mounting brackets
- Drawer front (NOT) included
- Waste container (NOT) included
- TSCA Title VI compliant

4WCCB-18SC-1



Waste container sold separately



Removeable food funnel for easy clean-up

Drawer Solutions

Full Access Cut-Out Cutting Board Drawer w/ TANDEM Slides

PRODUCT	DESCRIPTION	DIMS	MCO	CAB	FINISH	PRICE
4WCCB-419FLSC-1	Cut-Out Cutting Board Drawer	16-1/2" (419 mm)* W x 21-11/16" (551 mm) D x 4-5/16" (109 mm) H	16-1/2" (419 mm)	FLB18	Maple	\$282.75

Face Frame Cut-Out Cutting Board Drawer w/ TANDEM Slides

4WCCB-18SC-1	Cut-Out Cutting Board Drawer	15" (521 mm) W x 21-3/4" (553 mm) D x 4-5/16" (109 mm) H	15" (521 mm)	FFB18	Maple	\$270.70
--------------	------------------------------	--	--------------	-------	-------	----------



4WTCD-18SC-1



- Designed for 15", 18", 21", and 24" base cabinet drawers
- Complete drawer system, just add your drawer front
- Easy installation
- Natural maple construction with semi-gloss finish
- Full-extension, TANDEM, 110 lb. rated, concealed slides with BLUMOTION soft-close
- Drawer features up to (7) compartments
- Sliding top tray features up to (7) compartments
- Mounts to cabinet drawer front, rear and side walls
- Figure 8 door mount brackets
- TSCA Title VI compliant

**JUST ADD
YOUR OWN
DRAWER
FRONT!**



For video visit:
rev-a-shelf.com/videos



4WTCD-15-1 & 4WTCD-15SC-1
Face Frame Tiered Cutlery Drawer
(15" version shown)



4WTCD-18-1 & 4WTCD-18SC-1
Face Frame Tiered Cutlery Drawer
(18" version shown)



4WTCD-21-1 & 4WTCD-21SC-1
Face Frame Tiered Cutlery Drawer
(21" version shown)



4WTCD-24-1 & 4WTCD-24SC-1
Face Frame Tiered Cutlery Drawer
(24" version shown)



4WTCD-343FL-1 & 4WTCD-343FLSC-1
Full Access Tiered Cutlery Drawer
(15" version shown)



4WTCD-419FL-1 & 4WTCD-419FLSC-1
Full Access Tiered Cutlery Drawer
(18" version shown)



4WTCD-495FL-1 & 4WTCD-495FLSC-1
Full Access Tiered Cutlery Drawer
(21" version shown)



4WTCD-572FL-1 & 4WTCD-572FLSC-1
Full Access Tiered Cutlery Drawer
(24" version shown)

NOW YOU HAVE THE CHOICE!
AVAILABLE WITH BLUM® CONCEALED RUNNERS...OR PROVIDE YOUR OWN!
Designed to be used with BLUMOTION 563F533 or Grass Elite 7523-19/550/533 under mount slides.

Drawer Solutions

Full Access Tiered Cutlery Drawer, w/ BLUMOTION Soft-Close

PRODUCT	DESCRIPTION	DIMS	MCO	CAB	FINISH	SLP
4WTCD-343FLSC-1	Tiered Cutlery Drawer	13-1/2"(343 mm) W x 21-11/16"(551 mm) D x 4-1/4" (108 mm) H	13-1/2" (343 mm)	FLB15	Maple	\$224.70
4WTCD-419FLSC-1	Tiered Cutlery Drawer	16-1/2" (419 mm) W x 21-11/16" (551 mm) D x 4-1/4" (108 mm) H	16-1/2" (419 mm)	FLB18	Maple	\$241.30
4WTCD-495FLSC-1	Tiered Cutlery Drawer	19-1/2" (495 mm) W x 21-11/16" (551 mm) D x 4-1/4" (108 mm) H	19-1/2" (495 mm)	FLB21	Maple	\$241.15
4WTCD-572FLSC-1	Tiered Cutlery Drawer	22-1/2" (572 mm) W x 21-11/16" (551 mm) D x 4-1/4" (108 mm) H	22-1/2" (572 mm)	FLB24	Maple	\$282.75

Full Access Tiered Cutlery Drawer - No Slides

4WTCD-343FL-1	Tiered Cutlery Drawer	13"(330 mm) W x 21"(533 mm) D x 3-3/4"(95 mm) H	N/A	FLB15	Maple	\$163.10
4WTCD-419FL-1	Tiered Cutlery Drawer	16" (406 mm) W x 21" (533 mm) D x 3-3/4" (95 mm) H	N/A	FLB18	Maple	\$202.45
4WTCD-495FL-1	Tiered Cutlery Drawer	19" (483 mm) W x 21" (533 mm) D x 3-3/4" (95 mm) H	N/A	FLB21	Maple	\$213.35
4WTCD-572FL-1	Tiered Cutlery Drawer	22" (559 mm) W x 21" (533 mm) D x 3-3/4" (95 mm) H	N/A	FLB24	Maple	\$250.40

Face Frame Tiered Cutlery Drawer, w/ BLUMOTION Soft-Close

4WTCD-15SC-1	Tiered Cutlery Drawer	12" (305 mm) W x 21-1/2" (546 mm) D x 4-5/16" (110 mm) H	12" (305 mm)	FFB15	Maple	\$217.15
4WTCD-18SC-1	Tiered Cutlery Drawer	15" (381 mm) W x 21-1/2" (546 mm) D x 4-5/16" (110 mm) H	15" (381 mm)	FFB18	Maple	\$231.60
4WTCD-21SC-1	Tiered Cutlery Drawer	18" (457 mm) W x 21-1/2" (546 mm) D x 4-5/16" (110 mm) H	18" (457 mm)	FFB21	Maple	\$244.85
4WTCD-24SC-1	Tiered Cutlery Drawer	21" (533 mm) W x 21-1/2" (546 mm) D x 4-5/16" (110 mm) H	21" (533 mm)	FFB24	Maple	\$268.90

Face Frame Tiered Cutlery Drawer

4WTCD-15-1	Tiered Cutlery Drawer	11-1/2" (292 mm) W x 21" (534 mm) D x 3-3/4" (95 mm) H	N/A	FFB15	Maple	\$160.15
4WTCD-18-1	Tiered Cutlery Drawer	14-1/2" (368 mm) W x 21" (534 mm) D x 3-3/4" (95 mm) H	N/A	FFB18	Maple	\$192.40
4WTCD-21-1	Tiered Cutlery Drawer	17-1/2" (445 mm) W x 21" (534 mm) D x 3-3/4" (95 mm) H	N/A	FFB21	Maple	\$211.90
4WTCD-24-1	Tiered Cutlery Drawer	20-1/2" (521 mm) W x 21" (534 mm) D x 3-3/4" (95 mm) H	N/A	FFB24	Maple	\$226.30



- Designed for 30" and 36" base cabinet drawers
- Complete drawer system, just add your drawer front
- Easy installation
- Natural maple construction with semi-gloss finish
- Full-extension, under mount, concealed slides with BLUMOTION soft-close
- Drawer features up to (6) compartments and built-in knife organizer
- Sliding top tray features up to (5) compartments
- Mounts to cabinet side and rear wall
- Figure 8 door mounting brackets
- (1) Foil Wrap Insert
- Patent No. D843,791
- TSCA Title VI compliant



Drawer Solutions



For video visit:
rev-a-shelf.com/videos



4WTCD-724FLSC-1 & 4WTCD-724FL-1
 Tiered Combination Drawer
 (Full Access 30" shown)



4WTCD-36FLSC-1 & 4WTCD-36FL-1
 Tiered Combination Drawer
 (Face Frame 36" shown)



Sliding top tray features up to (5) compartments

4WTCD-876FLSC-1

Full Access Tiered Combination Drawer w/ BLUMOTION Soft-Close

PRODUCT	DESCRIPTION	DIMS	MCO	CAB	FINISH	SLP
4WTCD-724FLSC-1	Tiered Combination Drawer	28-1/2" (724 mm) W x 22-3/16" (564 mm) D x 4-7/16" (112 mm) H	28-1/2" (724 mm)	FLB30	Maple	\$441.00
4WTCD-876FLSC-1	Tiered Combination Drawer	34-1/2" (837 mm) W x 22-3/16" (564 mm) D x 4-7/16" (112 mm) H	34-1/2" (876 mm)	FLB36	Maple	\$482.55

Full Access Tiered Combination Drawer - No Slides

4WTCD-724FL-1	Tiered Combination Drawer	28" (711 mm) W x 21" (533 mm) D x 3-3/4" (95 mm) H	N/A	FLB30	Maple	\$279.75
4WTCD-876FL-1	Tiered Combination Drawer	34" (864 mm) W x 21" (533 mm) D x 3-3/4" (95 mm) H	N/A	FLB36	Maple	\$318.90

Face Frame Tiered Combination Drawer w/ BLUMOTION Soft-Close

4WTCD-30SC-1	Tiered Combination Drawer	26-15/16" (684 mm) W x 22-3/16" (564 mm) D x 4-3/8" (111 mm) H	27" (686 mm)	FFB30	Maple	\$428.20
4WTCD-36SC-1	Tiered Combination Drawer	32-15/16" (837 mm) W x 22-3/16" (564 mm) D x 4-3/8" (111 mm) H	30" (762 mm)	FFB36	Maple	\$470.75

Face Frame Tiered Combination Drawer - No Slides

4WTCD-30-1	Tiered Combination Drawer	26-7/16" (672 mm) W x 21" (533 mm) D x 3-3/4" (95 mm) H	N/A	FFB30	Maple	\$266.25
4WTCD-36-1	Tiered Combination Drawer	32-7/16" (824 mm) W x 21" (533 mm) D x 3-3/4" (95 mm) H	N/A	FFB36	Maple	\$308.45

Tiered K-Cup Drawer

4WTCD Series



- Designed for face frame 18" base cabinet drawers
- Complete drawer system, just add your drawer front
- Easy installation
- Natural maple construction with semi-gloss finish
- Full-extension, under mount, concealed slides with BLUMOTION soft-close
- Drawer features (8) compartments
- Sliding top tray holds (40) K-Cups
- Mounts to cabinet side and rear wall
- Figure 8 door mounting brackets
- TSCA Title VI compliant



4WTCD-18SC-KCUP-1 &
4WTCD-18-KCUP-1
Tiered K-Cup Drawer



For video visit:
rev-a-shelf.com/videos

Face Frame Tiered K-Cup Drawer w/ BLUMOTION Soft-Close

PRODUCT	DESCRIPTION	DIMS	MCO	CAB	FINISH	PRICE
4WTCD-18SC-KCUP-1	Tiered K-Cup Drawer	15" (381 mm) W x 21-1/2" (546 mm) D x 4-1/4" (108 mm) H	15" (381 mm)	FFB18	Maple	\$228.35

Face Frame Tiered K-Cup Drawer - No Slides

4WTCD-18-KCUP-1	K-Cup Drawer	14-7/16" (367 mm) W x 21" (533 mm) D x 3-3/4" (95 mm) H	N/A	FFB18	Maple	\$171.05
-----------------	--------------	---	-----	-------	-------	----------



- Designed for 18" base cabinet drawers
- Drawer front not included
- Natural maple construction with semi-gloss finish
- Full-extension, TANDEM, 110 lb. rated, concealed slides with BLUMOTION soft-close
- (2) 120V plugs and (2) 2.1 amp USB ports
- Tamper resistant outlets
- Max Current: AC: 12 amps @ 120VAC; USB 2.1 amp & 5 VDC
- UL recognized to UL962/CSA-C22.2 No. 0-10
- Power cord with NEMA 5 - 15 plug
- Integrated cord guide to ensure safe operation
- Door mount brackets
- Shock absorbent mat, black
- Overall safety of this product is determined by its end use
- TSCA Title VI compliant



Drawer Solutions

UP TO 16% FASTER CHARGING SPEED VS. COMPETITION!

4WCDB-18FLSC-1



4WCDB-18SC-1
Charging Drawer



Integrated cord guide to ensure safe operation mounts to cabinet side and rear wall



For video visit:
rev-a-shelf.com/videos

Full Access Charging Drawer w/ BLUMOTION Soft-Close

PRODUCT	DESCRIPTION	DIMS	MCO	CAB	FINISH	SLP
4WCDB-18FLSC-1	Charging Drawer	16-1/2" (419 mm) W x 22-3/4" (578 mm) D x 4-1/2" (114 mm) H	16-1/2" (419 mm)	FLB18	Maple	\$481.10

Face Frame Charging Drawer w/ BLUMOTION Soft-Close

4WCDB-18SC-1	Charging Drawer	15" (381 mm) W x 22-3/4" (578 mm) D x 4-1/2" (114 mm) H	15" (381 mm)	FFB18	Maple	\$484.20
--------------	-----------------	---	--------------	-------	-------	----------

Combination Knife Holder/ Cutting Board Drawer

4KCB Series



- Designed for 18", 21" and 24" face frame and 18" full access base cabinet drawers
 - Face Frame fits 1-1/2"
 - Full Access fits 3/4"
- Complete drawer system, just add your drawer front
- Natural maple construction with semi-gloss finish
- Full-extension, TANDEM, 110 lb. rated, concealed slides with BLUMOTION soft-close
- Up to (4) compartments and built-in knife organizer
- Mounts to cabinet drawer front, rear and side walls
- Figure 8 door mount brackets
- Built-in locking mechanism
- (1) wood cutting board
- Drawer front (NOT) included
- TSCA Title VI compliant

4KCB-419FLSC-1



Top tier stores the included cutting board



4KCB-21SC-1
Combination Drawer
(21" version shown)



4KCB-18SC-1
Combination Drawer
(18" version shown)



For video visit:
rev-a-shelf.com/videos

Full Access Combination Knife Holder/ Cutting Board Drawer w/ BLUMOTION Soft-Close

PRODUCT	DESCRIPTION	DIMS	MCO	CAB	FINISH	PRICE
4KCB-419FLSC-1	Combination Drawer	16-1/2" (419 mm) W x 22-1/8" (562 mm) D x 4-3/8" (111 mm) H	16-1/2" (419 mm)	FLB18	Maple	\$278.35

Combination Knife Holder/ Cutting Board Drawer w/ BLUMOTION Soft-Close

4KCB-18SC-1	Combination Drawer	15" (381 mm) W x 22-1/8" (562 mm) D x 4-3/8" (111 mm) H	15" (381 mm)	FFB18	Maple	\$284.45
4KCB-21SC-1	Combination Drawer	18" (456 mm) W x 22-1/8" (562 mm) D x 4-3/8" (111 mm) H	18" (457 mm)	FFB21	Maple	\$310.75
4KCB-24SC-1	Combination Drawer	21" (532 mm) W x 22-1/8" (562 mm) D x 4-3/8" (111 mm) H	21" (533 mm)	FFB24	Maple	\$337.75



- Designed for 12", 15" and 18" vanity base cabinet drawers
- Complete drawer system, just add your drawer front
- Easy installation
- Natural maple construction with semi-gloss finish
- Full-extension, TANDEM, 110 lb. rated, concealed slides with BLUMOTION soft-close
- Up to (7) compartments and up to (5) acrylic bins
- Non-skid vinyl lining
- Mounts to cabinet side and rear wall
- Figure 8 door mounting brackets
- TSCA Title VI compliant



4VDO-12SC-1



4VDOHT-15SC-1
Half-Tier Vanity Drawer
(15" Version Shown)



4VDOHT-276FLSC-1
Tiered Vanity Drawer
(12" Full Access Version Shown)



For video visit:
rev-a-shelf.com/videos

Drawer Solutions

Full Access Vanity Drawer w/ BLUMOTION Soft-Close

PRODUCT	DESCRIPTION	DIMS	MCO	CAB	FINISH	SLP
4VDO-267FLSC-1	Single Drawer	10-1/2" (267 mm) W x 18-11/16" (474 mm) D x 4-5/16" (109 mm) H	10-1/2" (267 mm)	FLVB12	Maple	\$167.70
4VDOT-267FLSC-1	Tiered Drawer	10-1/2" (267 mm) W x 18-11/16" (474 mm) D x 8" (204 mm) H	10-1/2" (267 mm)	FLVB12	Maple	\$237.30
4VDOHT-267FLSC-1	Half Tiered Drawer	10-1/2" (267mm) W x 18-11/16" (474 mm) D x 8" (204 mm) H	10-1/2" (267 mm)	FLVB12	Maple	\$228.70
4VDO-343FLSC-1	Single Drawer	13-1/2" (343 mm) W x 18-11/16" (474 mm) D x 4-5/16" (109 mm) H	13-1/2" (343 mm)	FLVB15	Maple	\$187.50
4VDOT343FLSC-1	Tiered Drawer	13-1/2" (343 mm) W x 18-11/16" (474 mm) D x 8" (204 mm) H	13-1/2" (343 mm)	FLVB15	Maple	\$264.55
4VDOHT-343FLSC-1	Half Tiered Drawer	13-1/2" (343 mm) W x 18-11/16" (474 mm) D x 8" (204 mm) H	13-1/2" (343 mm)	FLVB15	Maple	\$247.35
4VDO-419FLSC-1	Single Drawer	16-1/2" (419 mm) W x 18-11/16" (474 mm) D x 4-5/16" (109 mm) H	16-1/2" (419 mm)	FLVB18	Maple	\$207.20
4VDOT-419FLSC-1	Tiered Drawer	16-1/2" (419 mm) W x 18-11/16" (474 mm) D x 8" (204 mm) H	16-1/2" (419 mm)	FLVB18	Maple	\$291.50
4VDOHT-419FLSC-1	Half Tiered Drawer	16-1/2" (419 mm) W x 18-11/16" (474 mm) D x 8" (204 mm) H	16-1/2" (419 mm)	FLVB18	Maple	\$260.55

Face Frame Vanity Drawer w/ BLUMOTION Soft-Close

4VDO-12SC-1	Single Drawer	9" (228 mm) W x 18-11/16" (474 mm) D x 4-5/16" (109 mm) H	9" (229 mm)	FFVB12	Maple	\$160.85
4VDOT-12SC-1	Tiered Drawer	9" (228 mm) W x 18-11/16" (474 mm) D x 8" (204 mm) H	9" (229 mm)	FFVB12	Maple	\$224.15
4VDOHT-12SC-1	Half Tiered Drawer	9" (228 mm) W x 18-11/16" (474 mm) D x 8" (204 mm) H	9" (229 mm)	FFVB12	Maple	\$212.85
4VDO-15SC-1	Single Drawer	12" (304 mm) W x 18-11/16" (474 mm) D x 4-5/16" (109 mm) H	12" (305 mm)	FFVB15	Maple	\$179.05
4VDOT-15SC-1	Tiered Drawer	12" (304 mm) W x 18-11/16" (474 mm) D x 8" (204 mm) H	12" (305 mm)	FFVB15	Maple	\$251.35
4VDOHT-15SC-1	Half Tiered Drawer	12" (304 mm) W x 18-11/16" (474 mm) D x 8" (204 mm) H	12" (305 mm)	FFVB15	Maple	\$234.35
4VDO-18SC-1	Single Drawer	15" (380 mm) W x 18-11/16" (474 mm) D x 4-5/16" (109 mm) H	15" (381 mm)	FFVB18	Maple	\$198.20
4VDOT-18SC-1	Tiered Drawer	15" (380 mm) W x 18-11/16" (474 mm) D x 8" (204 mm) H	15" (381 mm)	FFVB18	Maple	\$274.50
4VDOHT-18SC-1	Half Tiered Drawer	15" (380 mm) W x 18-11/16" (474 mm) D x 8" (204 mm) H	15" (381 mm)	FFVB18	Maple	\$254.80

Wood Tambour Table

4TT Series



- Designed for 1-1/2" face frame 24" base cabinet drawers
- Complete drawer system, just add your drawer front
- Easy installation
- Natural maple construction with semi-gloss finish
- Over-extension, 220 lb. rated, table slides (static load)
- Adds 31-3/4" counter-top space
- Mounts to cabinet drawer rail and rear wall
- Patented door mount brackets with micro-adjustment (US Patent No. 8,388,076)
- TSCA Title VI compliant

4TT-2133-1



4TT-2133-1
Tambour Table

Drawer
Solutions

Face Frame Wood Tambour Table

PRODUCT	DESCRIPTION	DIMS	MCO	CAB	FINISH	SLP
4TT-2133-1	Tambour Table	22" (559 mm) W x 19-5/16-24" (491-610 mm) D x 4-3/4" (121 mm) H	21" (533 mm)	FFB24	Maple	\$372.35



4DPB-3921, DPS-PEG-4SS, 5DLD-1-CR

- Designed for 42" or smaller base cabinet drawers
- Trim-to-fit existing drawer
- Drop-in installation
- Natural maple construction with semi-gloss finish, walnut construction with satin finish or natural maple construction with sound dampening vinyl covering
- Up to (120) pre-drilled peg holes
- (9), (12) or (16) matching, press-in pegs (maple and walnut only)
- Compatible with chrome accessories (sold separately)
- TSCA Title VI compliant



Think outside the box



Perfect for vanities



Mix and match accessories for the perfect drawer solution



4DPS-WN-2421
Drawer Peg System
(Walnut finish shown)



4DPBG-3021-1
Drawer Peg Board
(Vinyl finish shown)



4DPS-3921
Drawer Peg System
(Maple finish shown)



4DPS-PEG-WN-4
(4) Wood Pegs
(Walnut finish shown)



DPS-PEG-4SS
(4) Stainless Steel Pegs



5DCH-2-1-CR
(2) Stainless Steel Containers



5DLD-1-CR
Lid Organizer

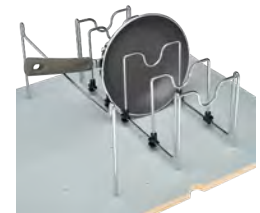

5DCD-1-CR
Pot & Pan Organizer

Drawer Peg System

PRODUCT	DESCRIPTION	DIMS	FINISH	SLP
4DPS-WN-2421	Peg System w/ (9) Pegs	24-1/4" (616 mm) W x 21-1/4" (540 mm) D x 6-5/8" (168 mm) H	Walnut	\$200.50
4DPS-WN-3021	Peg System w/ (12) Pegs	30-1/4" (769 mm) W x 21-1/4" (540 mm) D x 6-5/8" (168 mm) H	Walnut	\$258.40
4DPS-WN-3921	Peg System w/ (16) Pegs	39-1/4" (997 mm) W x 21-1/4" (540 mm) D x 6-5/8" (168 mm) H	Walnut	\$337.60
4DPS-2421	Peg System w/ (9) Pegs	24-1/4" (616 mm) W x 21-1/4" (540 mm) D x 6-5/8" (168 mm) H	Maple	\$75.20
4DPS-3021	Peg System w/ (12) Pegs	30-1/4" (769 mm) W x 21-1/4" (540 mm) D x 6-5/8" (168 mm) H	Maple	\$91.45
4DPS-3921	Peg System w/ (16) Pegs	39-1/4" (997 mm) W x 21-1/4" (540 mm) D x 6-5/8" (168 mm) H	Maple	\$118.05

Drawer Peg Board - No Pegs

4DPBG-2421-1	Vinyl Drawer Peg Board	24-1/8" (613 mm) W x 21-1/4" (540 mm) D x 5/8" (16 mm) H	Vinyl	\$75.45
4DPBG-3021-1	Vinyl Drawer Peg Board	30-1/8" (766 mm) W x 21-1/4" (540 mm) D x 5/8" (16 mm) H	Vinyl	\$94.35
4DPBG-3921-1	Vinyl Drawer Peg Board	39-1/8" (994 mm) W x 21-1/4" (540 mm) D x 5/8" (16 mm) H	Vinyl	\$117.75
4DPB-2421	Drawer Peg Board	24-1/4" (616 mm) W x 21-1/4" (540 mm) D x 5/8" (16 mm) H	Maple	\$62.85
4DPB-3021	Drawer Peg Board	30-1/4" (769 mm) W x 21-1/4" (540 mm) D x 5/8" (16 mm) H	Maple	\$75.10
4DPB-3921	Drawer Peg Board	39-1/4" (997 mm) W x 21-1/4" (540 mm) D x 5/8" (16 mm) H	Maple	\$95.90

Accessories

4DPS-PEG-4	(4) Maple Pegs	1-5/8" (41 mm) W x 1-5/8" (41 mm) D x 6-1/2" (165 mm) H	Maple	\$29.40
4DPS-PEG-WN-4	(4) Walnut Pegs	1-5/8" (41 mm) W x 1-5/8" (41 mm) D x 6-1/2" (165 mm) H	Walnut	\$58.00
DPS-PEG-4SS	(4) Stainless Steel Pegs	1-1/4" (32 mm) W x 1-1/4" (32 mm) D x 6" (153 mm) H	Stainless Steel	\$61.00
5DCH-2-1-CR	(2) Stainless Steel Containers	6-1/2" (165 mm) W x 10-1/4" (261 mm) D x 6-1/2" (165 mm) H	Stainless Steel	\$56.65
5DLD-1-CR	Lid Organizer	5-1/4" (134 mm) W x 16-7/8" (429 mm) D x 5-3/8" (137 mm) H	Chrome	\$23.45
5DCD-1-CR	Pot/Pan Organizer	7-3/4" (197 mm) W x 15-1/4" (388 mm) D x 7-5/8" (194 mm) H	Chrome	\$30.15

- Designed for 24" or smaller base cabinet drawers
- Trim-to-fit existing drawer
- Drop-in installation
- Natural maple construction with semi-gloss finish or walnut construction with satin finish
- Up to (9) compartments
- Shallow height sizes available
- Compatible with 4WD Wood Divider (Pg. 217) when using multiple inserts
- TSCA Title VI compliant



4WCT-WN-1SH/ 4WD-22SH-WN-1



4WCT-3SH
Wood Cutlery Tray Insert
(Maple finish shown)

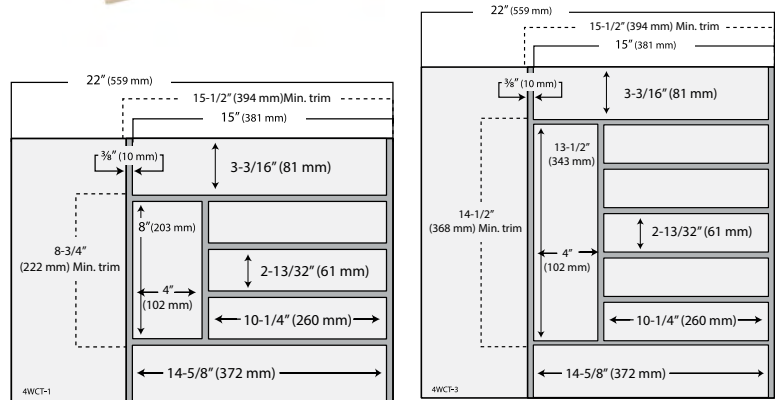

4WCT-1

4WCT-3



For video visit:
rev-a-shelf.com/videos

Shallow Wood Cutlery Tray Insert

PRODUCT	DESCRIPTION	DIMS	FINISH	SLP
4WCT-WN-1SH	Shallow Height Cutlery Tray	15-1/8" (384 mm) W x 22" (559 mm) D x 2-3/8" (60 mm) H	Walnut	\$137.40
4WCT-WN-3SH	Shallow Height Cutlery Tray	21-1/8" (537 mm) W x 22" (559 mm) D x 2-3/8" (60 mm) H	Walnut	\$185.85
4WCT-1SH	Shallow Height Cutlery Tray	14-5/8" (371 mm) W x 22" (559 mm) D x 2-3/8" (60 mm) H	Maple	\$69.75
4WCT-3SH	Shallow Height Cutlery Tray	20-5/8" (524 mm) W x 22" (559 mm) D x 2-3/8" (60 mm) H	Maple	\$91.60

Wood Cutlery Tray Insert

4WCT-1	Cutlery Tray	14-5/8" (371 mm) W x 22" (559 mm) D x 2-7/8" (73 mm) H	Maple	\$71.25
4WCT-3	Cutlery Tray	20-5/8" (524 mm) W x 22" (559 mm) D x 2-7/8" (73 mm) H	Maple	\$93.50

Wood Utensil Tray Insert

4WUT Series



- Designed for 36" or smaller base cabinet drawers
- Trim-to-fit existing drawer
- Drop-in installation
- Natural maple construction with semi-gloss finish or walnut construction with satin finish
- Up to (2) adjustable compartments
- Up to (12) static compartments
- Shallow height sizes available
- Compatible with 4FWI Foil Wrap Insert and 4WD Wood Divider (Pg. 217)
- TSCA Title VI compliant

4WUT-3

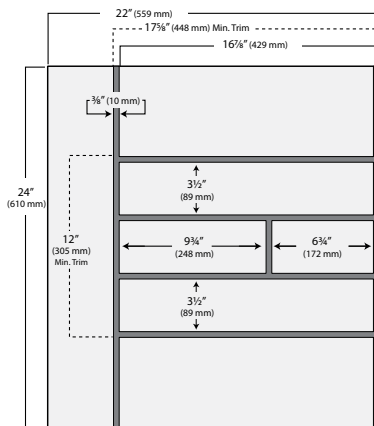

4WUT-3

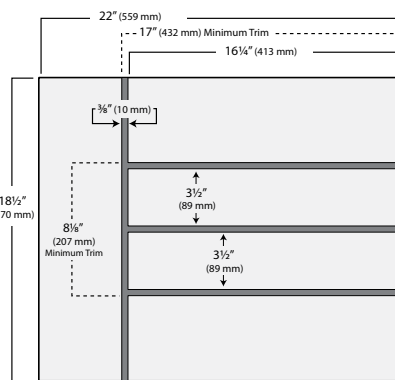

4WUT-1



4WUT-WN-1SH
Wood Utility Tray Insert
(Walnut finish shown)



For video visit:
rev-a-shelf.com/videos

Drawer
Solutions

Shallow Wood Utensil Tray Insert

PRODUCT	DESCRIPTION	DIMS	FINISH	SLP
4WUT-WN-1SH	Shallow Height Utility Tray	18-1/2" (470 mm) W x 22" (559 mm) D x 2-3/8" (60 mm) H	Walnut	\$95.30
4WUT-WN-3SH	Shallow Height Utility Tray	21-1/8" (537 mm) W x 22" (559 mm) D x 2-3/8" (60 mm) H	Walnut	\$128.90
4WUT-1SH	Shallow Height Utility Tray	18-1/2" (470 mm) W x 22" (559 mm) D x 2-3/8" (60 mm) H	Maple	\$51.65
4WUT-3SH	Shallow Height Utility Tray	24" (610 mm) W x 22" (559 mm) D x 2-3/8" (60 mm) H	Maple	\$67.40

Wood Utensil Tray Insert

4WUT-1	Utility Tray	18-1/2" (470 mm) W x 22" (559 mm) D x 2-7/8" (73 mm) H	Maple	\$52.60
4WUT-3	Utility Tray	24" (610 mm) W x 22" (559 mm) D x 2-7/8" (73 mm) H	Maple	\$68.50

Accessories

4FWI-16SS-1	16" Foil Wrap Insert for 4WUT	3-7/16" (86 mm) W x 16" (406 mm) D x 2-5/8" (66 mm) H	Stainless Steel	\$31.85
-------------	-------------------------------	---	-----------------	---------

Wide Drawer Inserts

4WUT-36-1	Utensil Drawer Insert	33-1/8" (841 mm) W x 19-3/4" (502 mm) D x 2-7/8" (73 mm) H	Maple	\$172.55
4WUTKB-36-1	Knife Block/ Utensil Drawer Insert	33-1/8" (841 mm) W x 19-3/4" (502 mm) D x 2-7/8" (73 mm) H	Maple	\$166.75
4WUTCT-36-1	Utensil/Cutlery Drawer Insert	33-1/8" (841 mm) W x 19-3/4" (502 mm) D x 2-7/8" (73 mm) H	Maple	\$172.55



- Designed for 36" or smaller base cabinet drawers
- Trim-to-fit existing drawer
- Drop-in installation
- Natural maple construction with semi-gloss finish or walnut construction with satin finish
- (1) rear compartment and up to (3) tiers
- Compatible with 4WD Wood Divider (Pg. 217) when using multiple inserts
- TSCA Title VI compliant



4SDI-24



4SDI-WN-18-1
Wood Spice Drawer Insert
(Walnut finish shown)

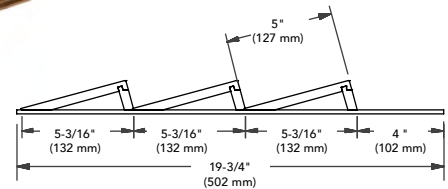

For video visit:
rev-a-shelf.com/videos

Wood Spice Drawer Insert

PRODUCT	DESCRIPTION	DIMS	FINISH	SLP
4SDI-WN-18-1	Spice Drawer Insert	16" (406 mm) W x 19-3/4" (502 mm) D x 1-1/2" (38 mm) H	Walnut	\$83.00
4SDI-WN-24-1	Spice Drawer Insert	22" (559 mm) W x 19-3/4" (502 mm) D x 1-1/2" (38 mm) H	Walnut	\$107.70
4SDI-18	Spice Drawer Insert	16" (406 mm) W x 19-3/4" (502 mm) D x 1-1/2" (38 mm) H	Maple	\$70.45
4SDI-24	Spice Drawer Insert	22" (559 mm) W x 19-3/4" (502 mm) D x 1-1/2" (38 mm) H	Maple	\$78.15

Wide Spice Drawer Insert

4SDI-36-1	Drawer Insert	33-1/8" (841 mm) W x 19-3/4" (502 mm) D x 1-3/4" (44 mm) H	Maple	\$166.75
-----------	---------------	--	-------	----------



- Designed for 18" and 24" base cabinet drawers
- Trim-to-fit existing drawer
- Drop-in installation
- Natural maple construction with semi-gloss finish
- Up to (4) compartments and (5) tiers that hold up to (30) K-Cups
- Compatible with 4WD Wood Divider (Pg. 217) when using multiple inserts
- TSCA Title VI compliant

4WUT-3

4CDI-24-KCUP-1
Wood K-CUP Drawer Insert
(24" version shown)

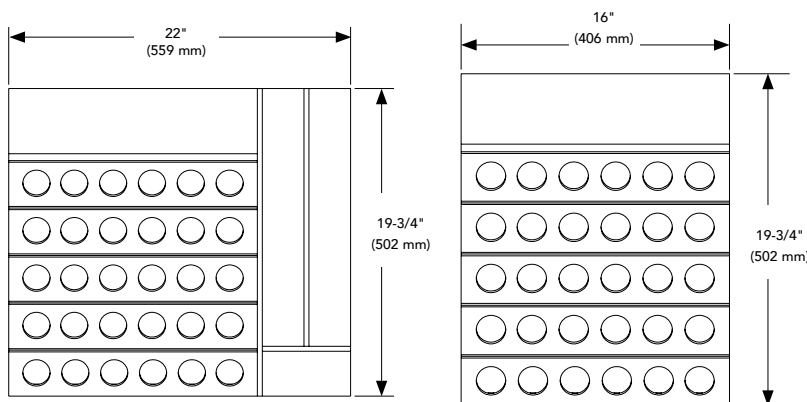
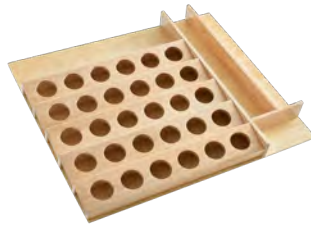

4CDI-24-KCUP-1

4CDI-18-KCUP-1



For video visit:
rev-a-shelf.com/videos

Wood K-Cup Drawer Insert

PRODUCT	DESCRIPTION	DIMS	FINISH	SLP
4CDI-18-KCUP-1	K-Cup Tray Insert	16" (406 mm) W x 19-3/4" (502 mm) D x 2-3/8" (61 mm) H	Maple	\$101.15
4CDI-24-KCUP-1	K-Cup Tray Insert	22" (559 mm) W x 19-3/4" (502 mm) D x 2-3/8" (61 mm) H	Maple	\$123.85

- Designed for 18-1/2" or smaller base cabinet drawers
- Trim-to-fit existing drawer
- Drop-in installation
- Natural maple construction with semi-gloss finish or walnut construction with satin finish
- (1) compartment and (2) tiers that include up to (55) knife slots
- Compatible with 4WD Wood Divider (Pg. 217) when using multiple inserts
- TSCA Title VI compliant

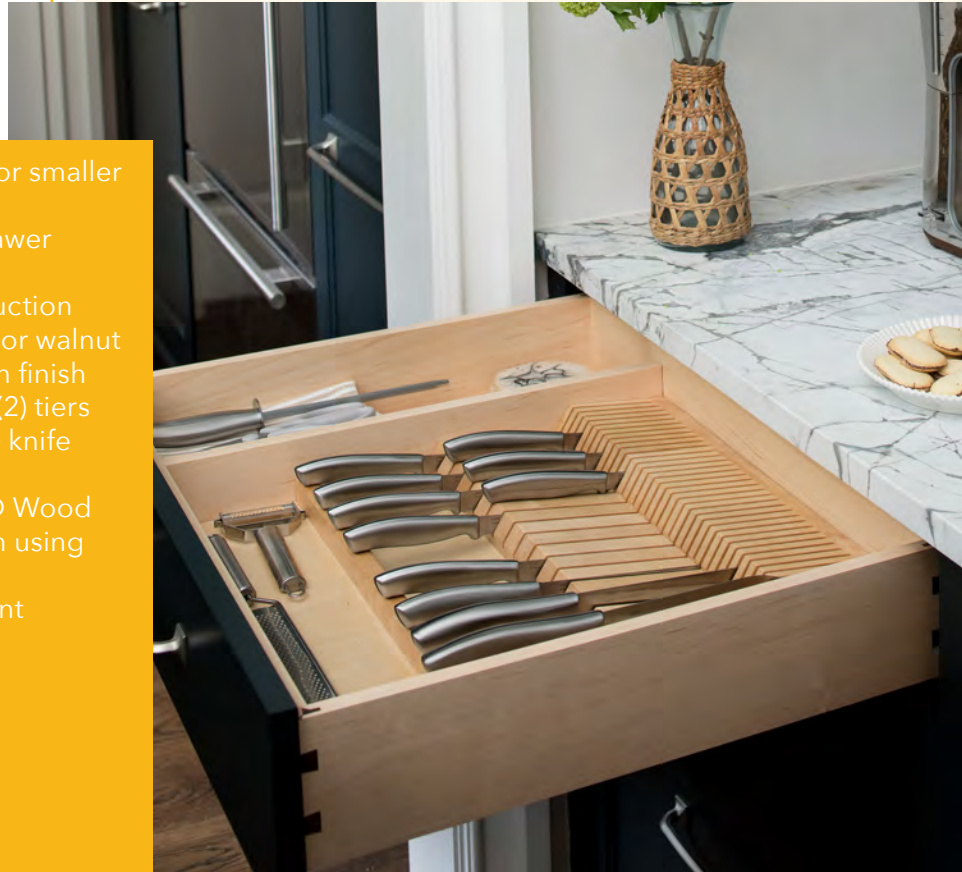

4WDKB-1



4WDKB-WN-1

Wood Double Knife Block
(Walnut finish shown)



For video visit:
rev-a-shelf.com/videos

Wood Double Knife Block Insert

PRODUCT	DESCRIPTION	DIMS	FINISH	SLP
4WDKB-WN-1	Double Knife Block Insert	18-1/2" (470 mm) W x 22" (559 mm) D x 2" (51 mm) H	Walnut	\$271.60
4WDKB-1	Double Knife Block Insert	18-1/2" (470 mm) W x 22" (559 mm) D x 2" (51 mm) H	Maple	\$94.05

Wood Knife Block Insert

4WKB Series



- Designed for 18-1/2" or smaller base cabinet drawers
- Trim-to-fit existing drawer
- Drop-in installation
- Natural maple construction with semi-gloss finish
- (1) compartment and up to (19) knife slots
- Compatible with 4WD Wood Divider (Pg. 217) when using multiple inserts
- TSCA Title VI compliant

Wood Knife Block Insert

PRODUCT	DESCRIPTION	DIMS	FINISH	PRICE
4WKB-1	Knife Block Insert	18-1/2" (470 mm) W x 22" (559 mm) D x 2-3/8" (60 mm) H	Maple	\$79.00

Wood Drawer Divider

4WD Series



- Designed for 22" D or smaller base cabinet drawers
- Trim-to-fit existing drawer
- Natural maple construction with semi-gloss finish or walnut construction with satin finish
- 2-3/8" shallow H or 2-7/8" H
- Compatible with 4WCT, 4WUT, 4WKB and 4SDI Inserts
- Easily combine various drawer inserts into wider drawer
- TSCA Title VI compliant

Shallow Height Wood Drawer Divider

PRODUCT	DESCRIPTION	DIMS	FINISH	PRICE
4WD-22SH-WN-1	Shallow Height Divider	1/2" (13 mm) W x 22" (559 mm) D x 2-3/8" (60 mm) H	Walnut	\$25.70
4WD-22SH-1	Shallow Height Divider	1/2" (13 mm) W x 22" (559 mm) D x 2-3/8" (60 mm) H	Maple	\$12.55

Wood Drawer Divider

4WD-22-1	Divider	1/2" (13 mm) W x 22" (559 mm) D x 2-7/8" (73 mm) H	Maple	\$12.70
----------	---------	--	-------	---------

- Designed for 24" or smaller base cabinet drawers
- Trim-to-fit existing drawer
- Drop-in installation
- Polystyrene construction with textured finish in white or almond, or glossy finish in white or metallic silver
- Up to (7) compartments
- Great for our outdoor applications

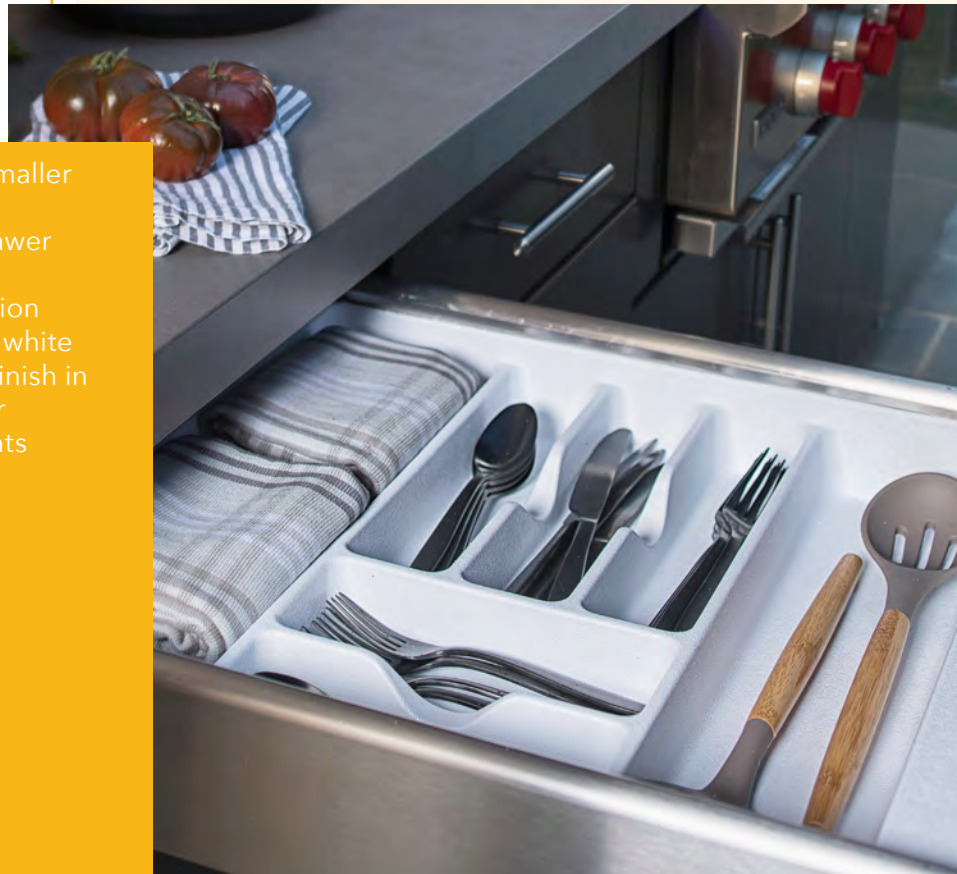

CT-2W-52



CT-1A-52
Polymer Cutlery Tray
(Almond finish shown)



GCT-2S-52
Polymer Cutlery Tray
(Metallic Silver finish shown)



CT-4W-52
Polymer Cutlery Tray
(White finish shown)

NOTE: Trays can be ordered trimmed to your specifications for an additional charge. Ships with a clear protective coating; remove before use.

* - Insert (W) for White, (A) for Almond and (S) For Metallic Silver. Add "G" to the beginning of the product number to designate Glossy finish.

Polymer Cutlery Tray

PRODUCT	DESCRIPTION	DIMS	MIN TRIM	FINISH	SLP
CT-1*-52	Cutlery Tray	11-1/2" (293 mm) W x 21-1/4" (540 mm) D x 2-3/8" (61 mm) H	8-5/8" (219 mm) W x 17-3/4" (451 mm) D	Polymer	\$18.40
CT-2*-52	Cutlery Tray	14-1/4" (362 mm) W x 21-1/4" (540 mm) D x 2-3/8" (61 mm) H	11-5/8" (296 mm) W x 17-3/4" (451 mm) D	Polymer	\$20.15
CT-3*-52	Cutlery Tray	17-1/2" (445 mm) W x 21-1/4" (540 mm) D x 2-3/8" (61 mm) H	14-3/4" (375 mm) W x 17-3/4" (451 mm) D	Polymer	\$23.65
CT-4*-52	Cutlery Tray	21-7/8" (556 mm) W x 21-1/4" (540 mm) D x 2-3/8" (61 mm) H	18-3/4" (467 mm) W x 17-3/4" (451 mm) D	Polymer	\$24.80

Polymer Cutlery Tray

CT-1*-10	(10) Cutlery Trays	11-1/2" (293 mm) W x 21-1/4" (540 mm) D x 2-3/8" (61 mm) H	8-5/8" (219 mm) W x 17-3/4" (451 mm) D	Polymer	\$13.80 ea.
CT-2*-20	(20) Cutlery Trays	14-1/4" (362 mm) W x 21-1/4" (540 mm) D x 2-3/8" (61 mm) H	11-5/8" (296 mm) W x 17-3/4" (451 mm) D	Polymer	\$14.20 ea.
CT-3*-20	(20) Cutlery Trays	17-1/2" (445 mm) W x 21-1/4" (540 mm) D x 2-3/8" (61 mm) H	14-3/4" (375 mm) W x 17-3/4" (451 mm) D	Polymer	\$16.55 ea.
CT-4*-10	(10) Cutlery Trays	21-7/8" (556 mm) W x 21-1/4" (540 mm) D x 2-3/8" (61 mm) H	18-3/4" (467 mm) W x 17-3/4" (451 mm) D	Polymer	\$16.95 ea.



- Designed for 24" or smaller base cabinet drawers
- Trim-to-fit existing drawer
- Drop-in installation
- Polystyrene construction with textured or glossy finish in white, or textured finish in almond
- Up to (4) compartments
- Great for our outdoor applications

GUT-18W-52



UT-10A-52

Polymer Utensil Tray
(Almond finish shown)

UT-12A-52

Polymer Utensil Tray
(Almond finish shown)

GUT-15W-52

Polymer Utensil Tray
(White finish shown)

NOTE: Trays can be ordered trimmed to your specifications for an additional charge. Ships with a clear protective coating; remove before use.

* - Insert (W) for White, (A) for Almond. Add "G" to the beginning of the product number to designate Glossy finish.

Polymer Utensil Tray

PRODUCT	DESCRIPTION	DIMS	MIN TRIM	FINISH	SLP
UT-10*-52	Utility Trays	11-1/2" (293 mm) W x 21-1/4" (540 mm) D x 2-3/8" (61 mm) H	8-5/8" (219 mm) W x 17-3/4" (451 mm) D	Polymer	\$19.00
UT-12*-52	Utility Trays	14-1/4" (362 mm) W x 21-1/4" (540 mm) D x 2-3/8" (61 mm) H	11-5/8" (296 mm) W x 17-3/4" (451 mm) D	Polymer	\$20.75
UT-15*-52	Utility Trays	17-1/2" (445 mm) W x 21-1/4" (540 mm) D x 2-3/8" (61 mm) H	14-3/4" (375 mm) W x 17-3/4" (451 mm) D	Polymer	\$24.35
UT-18*-52	Utility Trays	21-7/8" (556 mm) W x 21-1/4" (540 mm) D x 2-3/8" (61 mm) H	18-3/8" (467 mm) W x 17-3/4" (451 mm) D	Polymer	\$25.50

Polymer Utensil Trays

UT-10*-10	(10) Utility Trays	11-1/2" (293 mm) W x 21-1/4" (540 mm) D x 2-3/8" (61 mm) H	8-5/8" (219 mm) W x 17-3/4" (451 mm) D	Polymer	\$14.20 ea.
UT-12*-20	(20) Utility Trays	14-1/4" (362 mm) W x 21-1/4" (540 mm) D x 2-3/8" (61 mm) H	11-5/8" (296 mm) W x 17-3/4" (451 mm) D	Polymer	\$14.65 ea.
UT-15*-20	(20) Utility Trays	17-1/2" (445 mm) W x 21-1/4" (540 mm) D x 2-3/8" (61 mm) H	14-3/4" (375 mm) W x 17-3/4" (451 mm) D	Polymer	\$16.95 ea.
UT-18*-10	(10) Utility Trays	21-7/8" (556 mm) W x 21-1/4" (540 mm) D x 2-3/8" (61 mm) H	18-3/8" (467 mm) W x 17-3/4" (451 mm) D	Polymer	\$17.40 ea.

- Designed for 48" or smaller base cabinet drawers
- Trim-to-fit existing drawer
- Drop-in installation
- Polystyrene construction with textured finish, almond or white
- Up to (4) tiers
- Great for our outdoor applications



ST50-21W-52



ST50-21A-52
Polymer Spice Tray
(Almond finish shown)

NOTE: Trays can be ordered trimmed to your specifications for an additional charge. Ships with a clear protective coating; remove before use.

* - Insert (W) for White, (A) for Almond

Polymer Spice Tray

PRODUCT	DESCRIPTION	DIMS	FINISH	SLP
ST50-21*-52	Spice Tray	50" (1270 mm) W x 21" (534 mm) D	Polymer	\$59.60
(12) Polymer Spice Trays				
ST50-21*-12	Spice Tray	50" (1270 mm) W x 21" (534 mm) D	Polymer	\$52.80 ea.



- Designed for 24" or smaller base cabinet drawers
- Trim-to-fit existing drawer
- Easy installation
- Textured polymer available in almond, translucent or white
- Molded-in handle and rear stop
- Includes sliding rails and mounting screws



BDC24-11
Polymer Bread Drawer Cover
(White finish shown)



BDC24-11
Polymer Bread Drawer Cover
(Almond finish shown)

** - Insert (11) for White, (15) for Almond and (20) for translucent (for an additional cost).

Polymer Bread Drawer Cover

PRODUCT	DESCRIPTION	DIMS	MIN TRIM	FINISH	SLP
BDC-200-**	BDC Kit	16-3/4" (426 mm) W x 21-3/4" (553 mm) D	11-5/8" (295 mm) x Any Depth	Polymer	\$34.65
BDC-200-20	BDC Kit-Translucent w/Clear Rails	16-3/4" (426 mm) W x 21-3/4" (553 mm) D	11-5/8" (295 mm) x Any Depth	Polymer	\$61.05

Polymer Bread Drawer Cover

BDC24-**	BDC Kit	20-1/8" (511 mm) W x 21-3/4" (553 mm) D	16-1/16" (408 mm) x Any Depth	Polymer	\$36.40
BDC24-20	BDC Kit-Translucent w/ Clear Rails	20-1/8" (511 mm) W x 21-3/4" (553 mm) D	16-1/16" (408 mm) x Any Depth	Polymer	\$61.20

F-Channel Rail Kit

CDR-21W-A	Extra White Rails			White	\$16.70
CDR-21A-A	Extra Almond Rails			Almond	\$16.70
CDR-21C-A	Extra Clear Rails			Clear	\$23.80

NOTE: Cover is textured to hide scratches. Product available in three colors. These bread drawer covers can be ordered custom cut to your drawer specifications.

- Designed for 18" base cabinet drawers with 1-1/2" face frame
- Complete drawer system
- Easy installation
- Patented pre-assembled door mount brackets (US Patent No. 6,390,576)
- Chrome-plated wire construction
- Full-extension, ball-bearing, 100 lb. slides
- Stores either letter or legal sizes
- Mounts to cabinet side wall
- Door mount brackets



RAS-FDSM-DM15-1

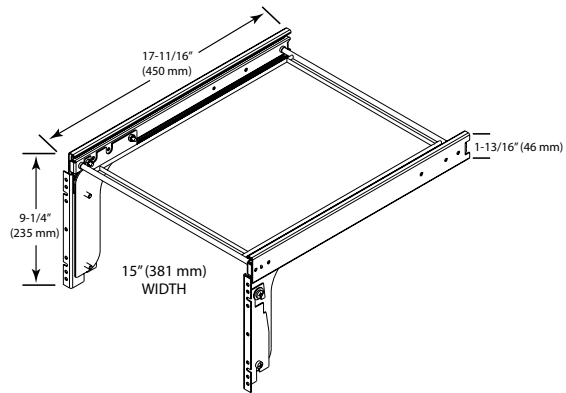

Pullout File Drawer System

PRODUCT	DESCRIPTION	DIMS	MCO	CAB	FINISH	SLP
RAS-FDSM-DM15-1	Drawer System	15" (381 mm) W x 17-11/16" (450 mm) D x 10-1/2" (267 mm) H	15" (381 mm)	B18	Polymer	\$56.00

Two-Tier File Drawer System



RAS-FD-KIT
Pullout File Drawer System

RAS-FD Series

- Designed for a standard height base 18" drawer/door cabinet
- Features full-extension, ball-bearing slides
- Heavy duty chrome plated rails
- Can store both letter and legal folders
- Mounting system based on 5WB2 Series wire baskets for sturdiness

Two-Tier File Drawer System

PRODUCT	DESCRIPTION	DIMS	MCO	CAB	FINISH	PRICE
RAS-FD-KIT	File Drawer System	14-3/4" (375 mm) W x 19-3/4" (597 mm) - 24" (610) D x 22-5/8" (575 mm) H	15" (381 mm)	B18	Chrome	\$94.30
RV-DM-FDKIT	(2) Door Mounting Kit				Silver	\$41.50

File Drawer System



RAS-**FD Series

- Designed for 18" and 21" base cabinet drawers
- Fits into existing drawer
- Drop-in installation
- Black, powder-coated wire construction
- RAS-LGFD includes T-rod connectors to store legal and letter sizes

File Drawer System

PRODUCT	DESCRIPTION	DIMS	MCO	CAB	FINISH	PRICE
RAS-SMFD-52	File System-Letter	13" (330 mm) W x 19-1/4" (489 mm) D x 9-3/4" (248 mm) H	15" (381 mm)	B18	Black	\$26.25
RAS-LGFD-52	File System-Legal	15-7/8" (403 mm) W x 19-1/4" (489 mm) D x 9-3/4" (248 mm) H	18" (457 mm)	B21	Black	\$29.15