

BASE

20/21.

Most of our organizational solutions are designed for base cabinet applications, so you always have a versatile list of innovative products to choose from. From face frame to full access, rest assured we have the perfect product sized for your type of cabinet. These popular base cabinet accessories are designed with the same superior quality you have come to expect from Rev-A-Shelf.



PROP 65 WARNING FOR CALIFORNIA RESIDENTS
WARNING: These products can expose you to chemicals such as formaldehyde, lead or styrene, which are known to the State of California to cause cancer and birth defects or other reproductive harm. For more information go to www.P65Warnings.ca.gov

4CW2 Series

Two-Tier Cookware Organizer



- Designed for 18" and 24" base cabinets
- Natural maple dovetail construction with semi-gloss finish
- Full-extension with 3/4" over-travel, undermount, 110 lb. rated slides with BLUM MOVENTO soft-close
- Up to 220 pre-drilled peg holes
- (4) matching, press-in pegs
- Top shelf holds lids w/ (1 w/18" or (2 w/24") lid organizers
- Mounts to cabinet floor
- TSCA Title VI compliant



4CW2-24SC-1



4CW2-1222-CR
Maple Cookware Organizer



Customizable

Wood Two-Tier Base Organizer Pullout

PRODUCT	DESCRIPTION	DIMS	MCO	CAB	FINISH	SLP
4CW2-18SC-1	Cookware Organizer	14-1/2" (368 mm) W x 22-1/4" (565 mm) D x 18-1/4" (464 mm) H	14-1/2" (368 mm)	B18	Maple	\$472.55
4CW2-24SC-1	Cookware Organizer	20-1/2" (521 mm) W x 22-1/4" (565 mm) D x 18-1/4" (464 mm) H	20-1/2" (521 mm)	B24	Maple	\$547.95

Towel Bar Base Filler Pullout

432TB Series



- Designed for 3" and 6" base cabinet applications
- Natural maple construction with semi-gloss finish
- (2) towel bars
- Single static shelf with chrome wire accents
- Full-extension, ball-bearing slides with soft-close
- Mounts between cabinets
- TSCA Title VI compliant

Base Solutions

432TB-BFBBSC-3C

Natural Maple Towel Bar Base Cabinet Filler w/ Ball-Bearing Soft-Close

PRODUCT	DESCRIPTION	DIMS	FINISH	SLP
432TB-BFBBSC-3C	3" Filler	3" (76 mm) W x 23" (584 mm) D x 30" (762 mm) H	Maple	\$187.35
432TB-BFBBSC-6C	6" Filler	6" (152 mm) W x 23" (584 mm) D x 30" (762 mm) H	Maple	\$277.65



- Designed for 14" to 22" cabinet depths
- Solid wood construction, natural maple or gray
- Mounts to cabinet top and rear
- (3) slide configurations:
 - Full-extension, ball-bearing, 100 lb. rated slides
 - Full-extension, 66 lb. rated, concealed slides with BLUMOTION soft-close
 - Stainless steel full-extension, ball-bearing, 100 lb. rated slides
- Up to (7) hooks
- TSCA Title VI compliant



GLD-W22-BC-7



For video visit:
rev-a-shelf.com/videos

NOTE: Dimensions are without the optional rear mounting bracket. Rear mounting bracket is 6-1/4" (159 mm) wide and adds 3/4" (19 mm)" to the depth, and 13/16" (20 mm) to the height.

MCO dimensions and CAB recommendations are dependent on what accessories you intend on hanging on product. Typical cookware will fit in B18



GLD-W14-SC-5
Glideware Pullout
w/ ball-bearing slide
and (5) Hooks
(14" version shown)



GLD-W22-BG-7
Glideware Pullout
w/ BLUMOTION Soft-Close
and (7) Hooks
(22" version shown)



Outdoor application



Closet application



GLD-P22-SSW-2
Polymer Glideware Pullout
w/ ball-bearing slide and (5) Hooks
(22" version shown)



Glideware Hooks
Nickel, Black, Brass, Copper, Zinc

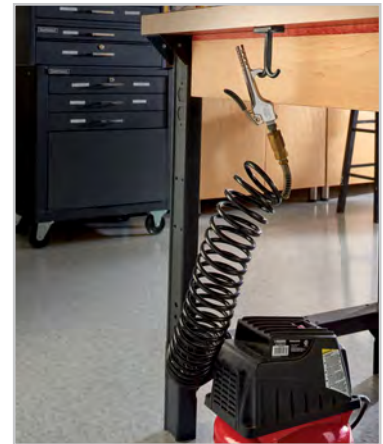

Use our B2B hooks for added storage anywhere you need

** - Insert BL for black, BR for brass, BZ for bronze, CP for copper and NC for nickel

Glideware Pullout w/ (5 or 7) Hooks					
PRODUCT	DESCRIPTION	DIMS	CAB	FINISH	SLP
GLD-W14-SC-5	14" Glideware	4" (102 mm) W x 14" (356 mm) D x 4-1/8" (105 mm) H	B9	Maple	\$86.40
GLD-W22-SC-7	22" Glideware	4" (102 mm) W x 22" (559 mm) D x 4-1/8" (105 mm) H	B9	Maple	\$105.95
Glideware Pullout w/ BLUMOTION Soft-Close and (5 or 7) Hooks					
GLD-W14-BC-5	14" Glideware	6" (153 mm) W x 14" (356 mm) D x 5-1/16" (128 mm) H	B9	Maple	\$196.80
GLD-W16-BC-5	16" Glideware	6" (153 mm) W x 16" (406 mm) D x 5-1/16" (128 mm) H	B9	Maple	\$202.70
GLD-W22-BC-7	22" Glideware	6" (153 mm) W x 22" (559 mm) D x 5-1/16" (128 mm) H	B9	Maple	\$233.20
GLD-W22-BG-7	22" Glideware	6" (153 mm) W x 22 (559 mm) D x 5-1/16" (128 mm) H	B9	Gray	\$235.20
Outdoor Polymer Glideware Pullout w/ Stainless Steel Slides and (5) Hooks					
GLD-P22-SSW-5	22" Glideware	4-1/4" (108 mm) W x 22-3/4" (578 mm) D x 5-1/8" (130 mm) H	B9	White	\$320.30
Glideware Accessories					
GLD-HK-S-ZC-7	(7) Glideware Short Hooks	1" (25 mm) W x 1-1/2" (38 mm) x 3-1/8" (80 mm) H		Zinc	\$5.10 ea.
GLD-HK-S-**-7	(7) Glideware Short Hooks	1" (25 mm) W x 1-1/2" (38 mm) x 3-1/8" (80 mm) H			\$11.55 ea.
GLD-HK-L-ZC-7	(7) Glideware Long Hooks	1" (25 mm) W x 1-1/2" (38 mm) x 4" (102 mm) H		Zinc	\$5.20 ea.
GLD-HK-L-**-7	(7) Glideware Long Hooks	1" (25 mm) W x 1-1/2" (38 mm) x 4" (102 mm) H			\$14.30 ea.
GLD-HK-2-ZC-5	(5) Glideware Back-to-Back Hooks	1" (25 mm) W x 2-43/64" (68 mm) x 3-1/8" (80 mm) H		Zinc	\$15.80 ea.
GLD-HK-2-**-5	(5) Glideware Back-to-Back Hooks	1" (25 mm) W x 2-43/64" (68 mm) x 3-1/8" (80 mm) H			\$15.80 ea.

596 Series

- Available in 10" height
- Chrome-plated round wire
- Mounts to cabinet floor
- Easy 4-screw installation
- Use multiple to create custom storage space

U-Shaped Tray Organizer

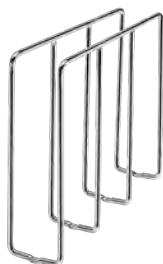

596-10CR-52
U-Shaped Tray Organizer



Simple bottom mount installation.

Base Solutions

Chrome Wire U-Shaped Tray Organizer

PRODUCT	DESCRIPTION	DIMS	FINISH	SLP
596-10CR-52	U-Shaped Tray Divider	3" (76 mm) W x 11-7/8" (302 mm) D x 10" (254 mm) H	Chrome	\$21.60

LD-597 Series

- Available in 12" and 18" height
- Chrome-plated round wire
- Mount to cabinet floor and rear wall
- Use multiple to create custom storage space

Chrome Tray Divider



LD-597-18CR-1

Chrome Wire Tray Divider

PRODUCT	DESCRIPTION	DIMS	FINISH	SLP
LD-597-12CR-1	12" Chrome Tray Divider	1/4" (6 mm) W x 20" (508 mm) D x 12" (305 mm) H	Chrome	\$14.25
LD-597-18CR-1	18" Chrome Tray Divider	1/4" (6 mm) W x 20" (508 mm) D x 18" (458 mm) H	Chrome	\$15.00

(10) Chrome Wire Tray Dividers

LD-597-12CR-10	(10) 12" Chrome Tray Dividers	1/4" (6 mm) W x 20" (508 mm) D x 12" (305 mm) H	Chrome	\$11.50 ea.
LD-597-18CR-10	(10) 18" Chrome Tray Dividers	1/4" (6 mm) W x 20" (508 mm) D x 18" (458 mm) H	Chrome	\$12.50 ea.



- Available in 12" and 18" height
- Chrome-plated or powder-coated white round wire
- Mount to cabinet floor and rear wall
- Includes (4) screw-in clips and fasteners each
- Use multiple to create custom storage space

597-18-52

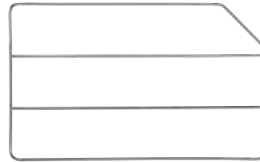

597-12CR-52
Tray Divider
(Chrome finish shown)

White Wire Tray Divider

PRODUCT	DESCRIPTION	DIMS	FINISH	SLP
597-12-52	Tray Divider with Clips	3/4" (19 mm) W x 20" (508 mm) D x 12" (305 mm) H	White Wire	\$10.40
597-18-52	Tray Divider with Clips	3/4" (19 mm) W x 20" (508 mm) D x 18" (458 mm) H	White Wire	\$11.90

(10) White Wire Tray Dividers

597-12-10	(10) 12" Tray Dividers with Clips	3/4" (19 mm) W x 20" (508 mm) D x 12" (305 mm) H	White Wire	\$7.95 ea.
597-18-10	(10) 18" Tray Dividers with Clips	3/4" (19 mm) W x 20" (508 mm) D x 18" (458 mm) H	White Wire	\$8.85 ea.

Chrome Wire Tray Divider

597-12CR-52	Tray Divider with Clips	3/4" (19 mm) W x 20" (508 mm) D x 12" (305 mm) H	Chrome Wire	\$14.20
597-18CR-52	Tray Divider with Clips	3/4" (19 mm) W x 20" (508 mm) D x 18" (458 mm) H	Chrome Wire	\$15.00

(10) Chrome Wire Tray Dividers

597-12CR-10	(10) 12" Tray Dividers with Clips	3/4" (19 mm) W x 20" (508 mm) D x 12" (305 mm) H	Chrome Wire	\$11.45 ea.
597-18CR-10	(10) 18" Tray Dividers with Clips	3/4" (19 mm) W x 20" (508 mm) D x 18" (458 mm) H	Chrome Wire	\$12.40 ea.

- Designed for 9" base cabinets
- Ball-bearing slides
- Universal brackets for right or left hand mounting
- Door mountable chrome frame

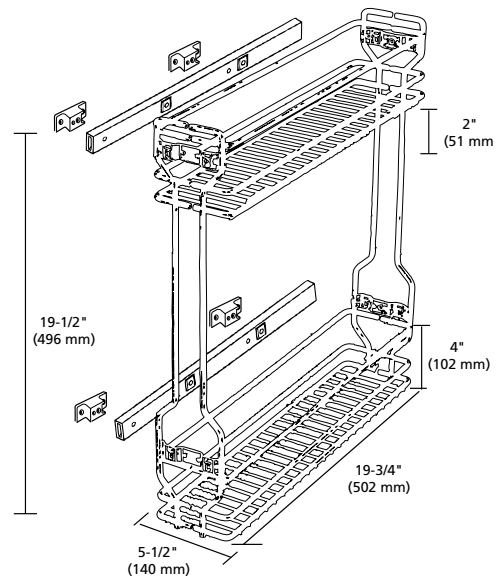
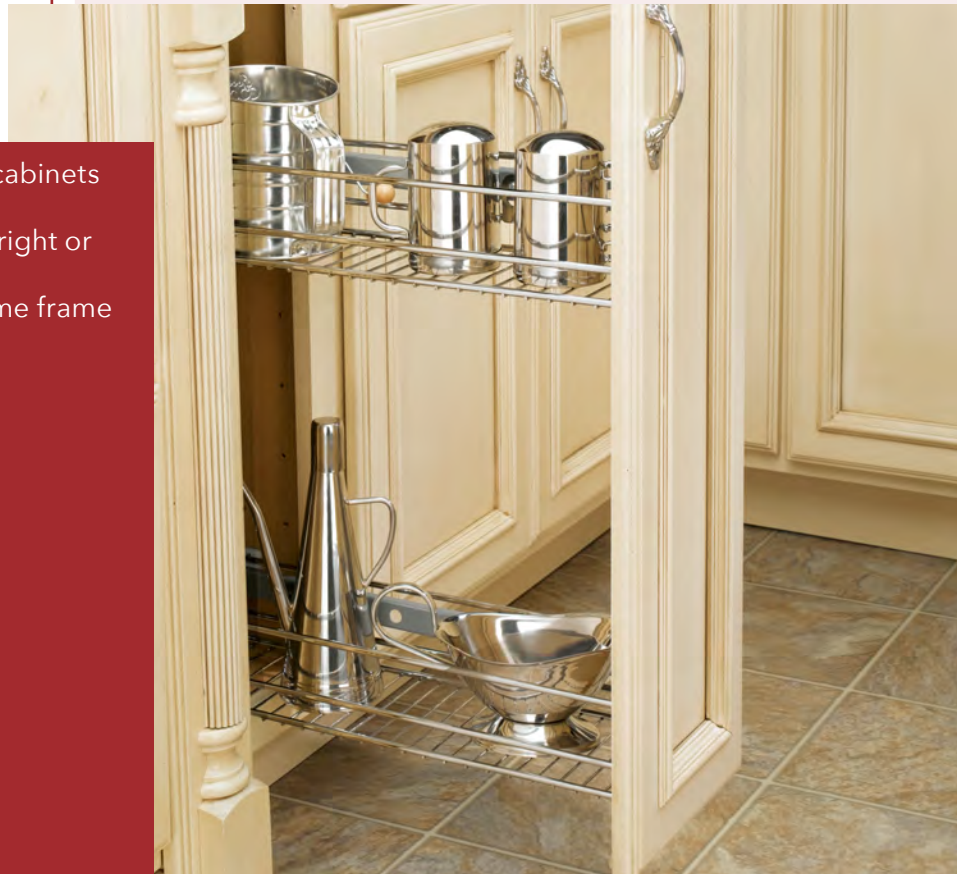

Chrome Two-Tier Base Organizer Pullout

PRODUCT	DESCRIPTION	DIMS	MCO	CAB	FINISH	SLP
548-06CR-1	Base Organizer	5-1/2" (140 mm) W x 19-3/4" (482 mm) D x 19-1/2" (496 mm) H	6" (152 mm)	B9	Chrome	\$94.60

Pullout Utility Basket

HURV Series



- Designed for 18" base cabinets
- Polymer basket, white
- White round wire frame
- Full-extension slides
- Easy 4-screw installation

HURV-1512 S

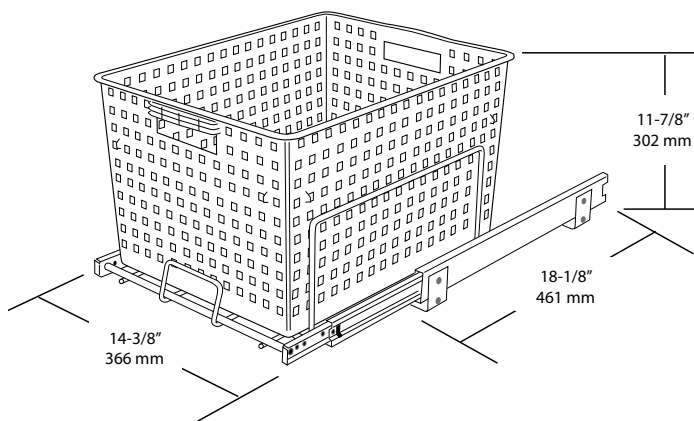

Polymer Utility Basket

PRODUCT	DESCRIPTION	DIMS	MCO	CAB	FINISH	SLP
HURV-1512 S	Utility Basket	14-3/8" (366 mm) W x 18-1/8" (461 mm) D x 11-7/8" (302 mm) H	15" (381 mm)	B18	Polymer	\$156.00
HUB-470X8	Replacement Utility Basket				Polymer	\$51.60
RV DM KIT	Heavy Duty Door Mount Kit				White	\$33.95



5WB2-1822-CR

5WB1

- Designed for 12" 15" 18" 21" and 24 " base cabinets
- Chrome-plated round wire frame ideal for organizing bulky items
- Full-extension, ball-bearing slides available in 18", 20" and 22" depths
- Easy 4-screw installation
- Door mount brackets available (sold separately)

5WB2

- Designed for 12" 15" 18" 21" and 24 " base cabinets
- Chrome-plated round wire
- Full-extension, ball-bearing slides
- 7-screw installation
- (3) adjustable heights
- Mounts to cabinet floor, side and rear wall
- Telescoping rear mounting bracket
- U-shaped support bracket
- Door mount brackets available (sold separately)



Door mount kit sold separately



Telescoping rear mounting bracket (Upper) attaches to the back wall of your cabinet



Top-down view of U-shaped support brackets



5WB1-1520-CR
Single Chrome Wire Pullout
(Shelf Base 18" Shown)

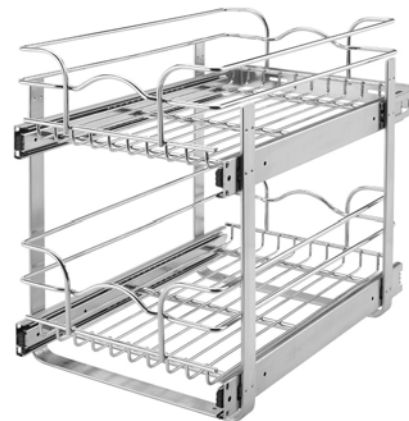

5WB2-1218-CR
Two-Tier Chrome Wire Pullout
(Shelves for Base 15" Shown)

Chrome Wire Pullout Shelf

PRODUCT	DESCRIPTION	DIMS	MCOFF	CAB	FINISH	SLP
5WB1-0918-CR	Pullout Shelf	8-3/8" (213 mm) W x 18" (457 mm) D x 7" (178 mm) H	8-1/2" (216 mm)	B12	Chrome	\$57.05
5WB1-1218-CR	Pullout Shelf	11-3/8" (289 mm) W x 18" (457 mm) D x 7" (178 mm) H	11-1/2" (292 mm)	B15	Chrome	\$61.80
5WB1-1220-CR	Pullout Shelf	11-3/8" (289 mm) W x 20" (508 mm) D x 7" (178 mm) H	11-1/2" (292 mm)	B15	Chrome	\$70.05
5WB1-1520-CR	Pullout Shelf	14-3/8" (365 mm) W x 20" (508 mm) D x 7" (178 mm) H	14-1/2" (356 mm)	B18	Chrome	\$78.50
5WB1-1222-CR	Pullout Shelf	11-3/8" (289 mm) W x 21-11/16" (550 mm) D x 7" (178 mm) H	11-1/2" (292 mm)	B15	Chrome	\$76.10
5WB1-1522-CR	Pullout Shelf	14-3/8" (365 mm) W x 21-11/16" (550 mm) D x 7" (178 mm) H	14-1/2" (356 mm)	B18	Chrome	\$84.70
5WB1-1822-CR	Pullout Shelf	17-3/8" (441 mm) W x 21-11/16" (550 mm) D x 7" (178 mm) H	17-1/2" (445 mm)	B21	Chrome	\$91.55
5WB1-2122-CR	Pullout Shelf	20-3/8" (518 mm) W x 21-11/16" (550 mm) D x 7" (178 mm) H	20-1/2" (521 mm)	B24	Chrome	\$100.10

Two-Tier Chrome Wire Pullout Shelves

5WB2-0918-CR	Pullout Shelves	8-3/4" (222 mm) W x 18" (457 mm) D x 19" (483 mm) H	8-1/2" (216 mm)	B12	Chrome	\$128.55
5WB2-1218-CR	Pullout Shelves	11-3/4" (299 mm) W x 18" (457 mm) D x 19" (483 mm) H	11-1/2" (292 mm)	B15	Chrome	\$141.95
5WB2-1222-CR	Pullout Shelves	11-3/4" (299 mm) W x 21-11/16" (550 mm) D x 19" (483 mm) H	11-1/2" (292 mm)	B15	Chrome	\$158.00
5WB2-1522-CR	Pullout Shelves	14-3/4" (375 mm) W x 21-11/16" (550 mm) D x 19" (483 mm) H	14-1/2" (356 mm)	B18	Chrome	\$162.05
5WB2-1822-CR	Pullout Shelves	17-3/4" (451 mm) W x 21-11/16" (550 mm) D x 19" (483 mm) H	17-1/2" (445 mm)	B21	Chrome	\$176.15
5WB2-2122-CR	Pullout Shelves	20-3/4" (527 mm) W x 21-11/16" (550 mm) D x 19" (483 mm) H	20-1/2" (521 mm)	B24	Chrome	\$191.40

Accessories

5WB-DMKIT	Door Mount Kit for Wire Pullout				Silver	\$33.90
-----------	---------------------------------	--	--	--	--------	---------



5CW2-2122-CR

- Designed for 15" and 24" base cabinets
- Chrome-plated wire frame
- (2) slide configurations:
 - Full-extension, ball-bearing slides, 100 lb. rated
 - Full-extension, ball-bearing slides, 100 lb. rated with soft-close
- Independently operating shelves that accommodate a variety of cookware sizes and brands
- Top tier organizes lids
- Bottom tier with adjustable dividers stores a variety of larger pots and pans
- Mounts to cabinet floor, side and rear wall (US Patent No: D588,415)
- U-shaped bracket for added support
- Door mount brackets available (sold separately)

Base Solutions



For video visit:
rev-a-shelf.com/videos

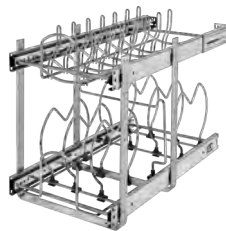

5CW2-1222-CR
 Cookware Organizer
 Holds (7) Lids

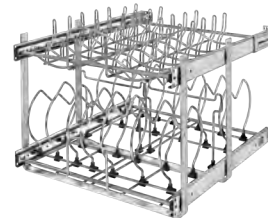

5CW2-2122-CR
 Cookware Organizer
 Holds (14) Lids



Door mount kit, sold separately

Two-Tier Cookware Organizer Pullout

PRODUCT	DESCRIPTION	DIMS	MCO	CAB	FINISH	SLP
5CW2-1222-CR	Cookware Organizer	11-3/4" (299 mm) W x 22" (559 mm)D x 18" (457 mm)H	12" (305 mm)	B15	Chrome	\$167.30
5CW2-2122-CR	Cookware Organizer	20-3/4" (527 mm) W x 22" (559 mm)D x 18-1/8" (460 mm)H	21" (533 mm)	B24	Chrome	\$303.35

Two-Tier Cookware Organizer w/ Ball-Bearing Soft-Close

5CW2-1222SC-CR	Cookware Organizer	11-3/4" (299 mm) W x 22" (559 mm)D x 18" (457 mm)H	12" (305 mm)	B15	Chrome	\$191.95
5CW2-2122SC-CR	Cookware Organizer	20-3/4" (527 mm) W x 22" (559 mm)D x 18-1/8" (460 mm)H	21" (533 mm)	B24	Chrome	\$348.65

Accessories

5WB-DMKIT	Door Mount Kit				Silver	\$33.90
-----------	----------------	--	--	--	--------	---------

Base Door Storage



4SBSU-15

4SBSU Series

- Designed for 15", 18" and 21" base cabinet doors
- Natural maple construction with semi-gloss finish
- Patented door mount brackets (US Patent No. 7,204,569)
- Easy 4-screw installation
- TSCA Title VI compliant



Includes removeable top tray

Parse
Solutions

Door Mount Base Door Storage

PRODUCT	DESCRIPTION	DIMS	MCO	CAB	FINISH	SLP
4SBSU-15	Door Storage	10-1/2" (267 mm) W x 5" (127 mm) D x 18-1/2" (470 mm) H	12" (305 mm)	B15	Maple	\$64.40
4SBSU-18	Door Storage	13-1/2" (343 mm) W x 5" (127 mm) D x 18-1/2" (470 mm) H	15" (381 mm)	B18	Maple	\$70.05
4SBSU-21	Door Storage	16-1/2" (419 mm) W x 5" (127 mm) D x 18-1/2" (470 mm) H	18" (457 mm)	B21	Maple	\$81.05

Grocery Bag Holder



4SPBD-15

4SPBD Series

- Designed for 15" and 18" base cabinet doors
- Natural maple construction with semi-gloss finish
- Patented adjustable door mount brackets (US Patent No. 7,204,569)
- TSCA Title VI Compliant



Includes removeable top tray

Door Mount Grocery Bag Holder

PRODUCT	DESCRIPTION	DIMS	MCO	CAB	FINISH	SLP
4SPBD-15	Door Storage	10-1/2" (267 mm) W x 5" (127 mm) D x 18-5/8" (473 mm) H	12" (305 mm)	B15	Maple	\$80.90
4SPBD-18	Door Storage	13-1/2" (343 mm) W x 5" (127 mm) D x 18-5/8" (473 mm) H	15" (381 mm)	B18	Maple	\$88.65

- Designed for 15" and 18" base cabinets
- Natural maple support rack with chrome-plated round wire
- Available with a mineral oil treated, maple hardwood cutting board or a Polyethylene cutting board
- Patented adjustable door mount brackets (US Patent No. 7,204,569)
- TSCA Title VI compliant



4DMCB-18



4DMCB-15
Wood Cutting Board
(15" Version shown)



4DMCB-18P
Polyethylene Cutting Board
(18" Version shown)



Adjustable Mounting Brackets
(US Patent No. 7,204,569)

Natural Maple Door Mount Cutting Board

PRODUCT	DESCRIPTION	DIMS	MCO	CAB	FINISH	SLP
4DMCB-15	Cutting Board	10-1/2" (267 mm) W x 2-7/8" (73 mm) D x 16-7/8" (429 mm) H	12" (305 mm)	B15	Maple	\$87.05
4DMCB-18	Cutting Board	13-1/2" (343 mm) W x 2-7/8" (73 mm) D x 16-7/8" (429 mm) H	15" (381 mm)	B18	Maple	\$98.40

Polyethylene Door Mount Cutting Board

4DMCB-15P	Cutting Board	11-5/16" (287 mm) W x 2" (51 mm) D x 16-7/16" (417 mm) H	12" (305 mm)	B15	Polyethylene/Maple	\$78.85
4DMCB-18P	Cutting Board	14-3/4" (374 mm) W x 2" (51 mm) D x 16-7/16" (417 mm) H	15" (381 mm)	B18	Polyethylene/Maple	\$99.75



- 8", 11", 14" and 20" width trays
- Natural maple construction with chrome-plated round wire
- (1) or (5) tray sets
- Easy-to-install screw-in clips
- Trays can also be mounted to 26" or 58" aluminum standards (sold separately)
- TSCA Title VI compliant

4231-11-52



14" Trays can be used with aluminum standards (Sold separately)



Bracket Extension Kit (Sold separately)



4231-14-52
Door Storage Tray
(8" Version shown)

NOTE: Additional tray clips may be ordered - Part No: 6231-41-4101-10

Door Storage Tray w/ Screw-In Clips

PRODUCT	DESCRIPTION	DIMS	MCO	CAB	FINISH	SLP
4231-08-52	8" Wood Door Mount Storage Tray	7-3/4" (197 mm) W x 4-1/4" (108 mm) D x 3-9-16" (90 mm) H	8-1/2" (216 mm)	B12	Maple	\$38.85
4231-11-52	11" Wood Door Storage Tray	10-3/4" (273 mm) W x 4-1/4" (108 mm) D x 3-5/8" (91 mm) H	12" (305 mm)	B15	Maple	\$41.25
4231-14-52	14" Wood Door Storage Tray	13-3/4" (349 mm) W x 4-1/4" (108 mm) D x 3-5/8" (91 mm) H	15" (381 mm)	B18	Maple	\$45.95
4231-20-52	20" Wood Door Storage Tray	19-3/4" (502 mm) W x 4-1/4" (108 mm) D x 3-5/8" (91 mm) H	21" (533 mm)	B24	Maple	\$51.40

(5) Door Storage Trays w/ Screw-In Clips

4235-11-5	11" Wood Door Storage Trays	10-3/4" (273 mm) W x 4-1/4" (108 mm) D x 3-5/8" (91 mm) H	12" (305 mm)	B15	Maple	\$31.70 ea.
4235-14-5	14" Wood Door Storage Trays	13-3/4" (349 mm) W x 4-1/4" (108 mm) D x 3-5/8" (91 mm) H	15" (381 mm)	B18	Maple	\$33.60 ea.
4235-20-5	20" Wood Door Storage Trays	19-3/4" (502 mm) W x 4-1/4" (108 mm) D x 3-5/8" (91 mm) H	21" (533 mm)	B24	Maple	\$39.05 ea.

Accessories

6230-MB-11-1	Mounting Bracket Extension Kit				White	\$12.75
6232-26-4528-52	Pair Aluminum Standards w/ (4) Clips	26" (660 mm) L			Alum	\$52.90
6232-58-4528-52	Pair Aluminum Standards w/ (10) Clips	58" (1473 mm) L			Alum	\$81.05

- Designed for 36" full height base cabinets
- Kit includes two swing out units and two door storage units
- Natural maple construction with semi-gloss finish
- Adjustable interior door and pantry shelves
- Chrome-plated accents
- Industrial piano hinge
- TSCA Title VI compliant

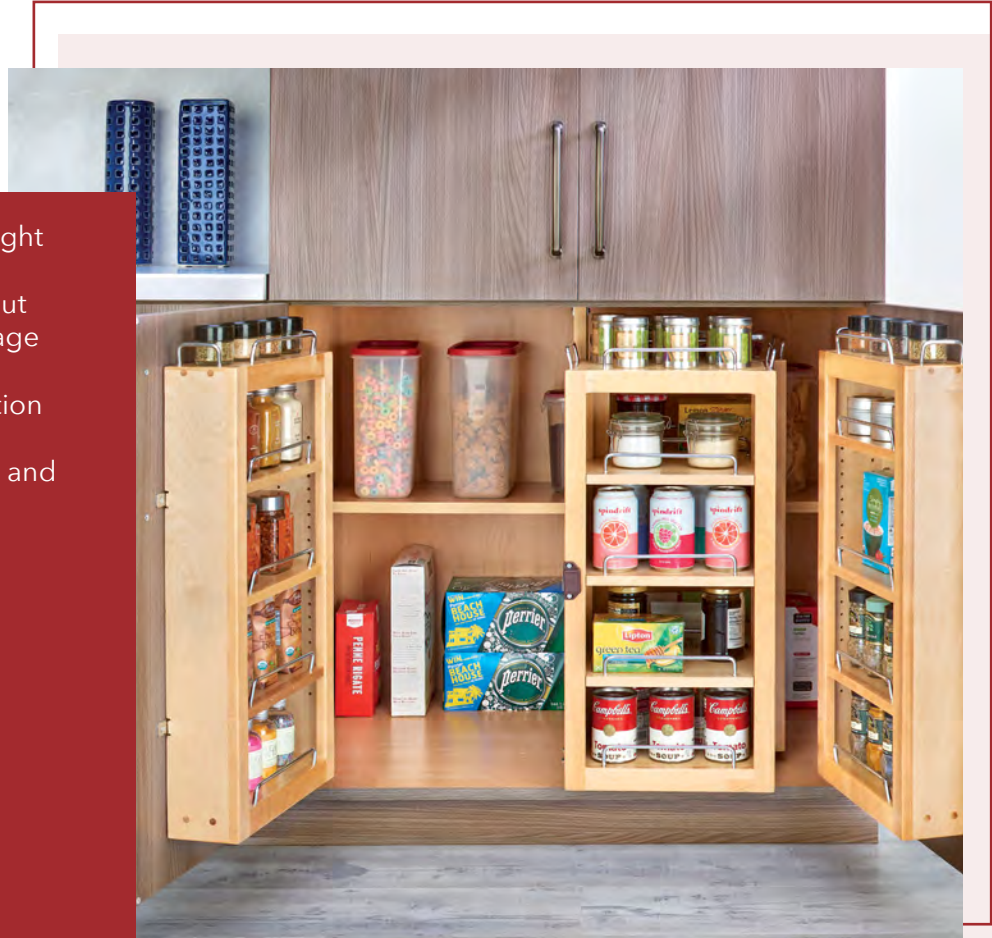

4WBP18-25-KIT
Swing Out Pantry Kit
(2) 4WBSP18-25 and (2) 4WBDP18-25

Chrome tap rails can be installed to store items.

NOTE: Minimum CABINET Height: 4WBP18-25-KIT = 25-3/4" (654 mm) without top rails or 28- 3/4" (730 mm) with top rails

Swing Out Pantry

PRODUCT	DESCRIPTION	DIMS	MCO	CAB	FINISH	SLP
4WBP18-25-KIT	25" Swing Out Pantry Kit - Includes (2) 4WBSP18-25 and (2) 4WBDP18-25		33" (838 mm)	FHB36	Maple	\$450.20
4WBSP18-25	(1) 25" Swing Out Pantry Unit w/Hardware	12" (305 mm) W x 7-1/2" (191 mm) D x 25" (635 mm) H	33" (838 mm)	FHB36	Maple	\$124.25
4WBDP18-25	(1) 25" Pantry Door Unit w/Hardware	12" (305 mm) W x 4" (102 mm) D x 25" (635 mm) H	33" (838 mm)	FHB36	Maple	\$111.50

Vanity Storage Rack

4VR Series



- Designed for 12", 15", 18", 21 and 24" vanity base cabinets
- Natural maple frame with semi-gloss finish
- Mounts to cabinet door
- Patented adjustable door mount brackets that provides up to 5" adjustability (US Patent No. 7,204,569)
- (2) non-skid vinyl shelves with acrylic accents
- TSCA Title VI compliant

Page
Solutions

4VR-15-1



Adjustable Mounting Brackets
(US Patent No. 7,204,569)



4VR-12-1
Storage Rack
(12" version shown)

4VR-21-1
Storage Rack for 21"
(21" version shown)



For video visit:
rev-a-shelf.com/videos

Door Mount Vanity Storage Rack

PRODUCT	DESCRIPTION	DIMS	MCO	CAB	FINISH	SLP
4VR-12-1	Storage Rack for 12"	8-1/4" (209 mm) W x 3-1/8" (80 mm) D x 15-1/2" (394 mm) H	9" (229 mm)	VB12	Maple	\$69.95
4VR-15-1	Storage Rack for 15"	11-1/4" (285 mm) W x 3-1/8" (80 mm) D x 15-1/2" (394 mm) H	12" (305 mm)	VB15	Maple	\$76.60
4VR-18-1	Storage Rack for 18"	14-1/4" (362 mm) W x 3-1/8" (80 mm) D x 15-1/2" (394 mm) H	14" (356 mm)	VB18	Maple	\$92.35
4VR-21-1	Storage Rack for 21"	17-1/4" (438 mm) W x 3-1/8" (80 mm) D x 15-1/2" (394 mm) H	17" (178 mm)	VB21	Maple	\$100.10
4VR-24-1	Storage Rack for 24"	20-1/4" (514 mm) W x 3-1/8" (80 mm) D x 15-1/2" (394 mm) H	21" (533 mm)	VB24	Maple	\$98.60



- Designed for 15" and 18" base cabinets
- (1) woven nylon basket:
 - Espresso with natural maple rails and semi-gloss finish
 - Espresso with walnut rails and satin finish
- 6-screw installation
- Trim-to-fit rails
- Rails are natural maple with semi-gloss finish or walnut with satin finish
- Mounts to cabinet side walls
- (1) machine washable canvas liner
- TSCA Title VI compliant



Base Solutions



4WV-15MP
Woven Basket with Rails
(15" Maple Version shown)

4WBP18-25-KIT



New woven nylon construction

PART	Inside Cabinet Width (Min.)	Inside Cabinet Width (Max.)	Basket Frame Width
4WV-15MP	12-3/8" (314 mm)	14-11/16" (373 mm)	11-5/16" (287 mm)
4WV-15WN	12-3/8" (314 mm)	14-11/16" (373 mm)	11-5/16" (287 mm)
4WV-18MP	15-3/8" (391 mm)	17-11/16" (449 mm)	14-5/16" (379 mm)
4WV-18WN	15-3/8" (391 mm)	17-11/16" (449 mm)	14-5/16" (379 mm)

Woven Basket

PRODUCT	DESCRIPTION	DIMS	MCO	CAB	FINISH	SLP
4WV-15MP	Woven Basket with Maple Rails	14-11/16" (373 mm) W x 21-1/4" (540 mm) D x 7-3/8" (188 mm) H	12" (305 mm)	B15	Maple	\$173.25
4WV-15WN	Woven Basket with Walnut Rails	14-11/16" (373 mm) W x 21-1/4" (540 mm) D x 7-3/8" (188 mm) H	12" (305 mm)	B15	Walnut	\$274.60
4WV-18MP	Woven Basket with Maple Rails	17-11/16" (449 mm) W x 21-1/4" (540 mm) D x 7-3/8" (188 mm) H	15" (381 mm)	B18	Maple	\$182.50
4WV-18WN	Woven Basket with Walnut Rails	17-11/16" (449 mm) W x 21-1/4" (540 mm) D x 7-3/8" (188 mm) H	15" (381 mm)	B18	Walnut	\$292.25



- Designed for 15" and 18" base cabinets
- Veneer plywood dovetail construction
- 3/4-extension slides or full-extension, 100 lb. rated slides with BLUMOTION soft-close
- Tall drawers feature peg board bottoms with (3, 4) pegs and (6,8) maple pegs
- TSCA Title VI compliant

4WDB7-24SC-1/4WDB4-18SC-1

Pictured with our K-Cup Insert, sold separately (three units shown)



4WDB7-24SC-1
Drawer Pullout
(24" with dividers version shown)



4WDB-12
Drawer Pullout
(15" Version shown)

Drawer Pullout w/ Euro Slides

PRODUCT	DESCRIPTION	DIMS	MCO	CAB	FINISH	SLP
4WDB-12	Pullout Drawer	11" (280 mm) W x 18-1/2" (470 mm) D x 5-5/8" (143 mm) H	12" (305 mm)	B15	Maple	\$83.80
4WDB-15	Pullout Drawer	14" (356 mm) W x 22-1/2" (572 mm) D x 5-5/8" (143 mm) H	15" (381 mm)	B18	Maple	\$97.00

Drawer Pullout w/ BLUMOTION Soft-Close

4WDB4-18SC-1	Standard Drawer	14" (356 mm) W x 21-5/8" (549 mm) D x 4-7/8" (124 mm) H	15" (381 mm)	B18	Maple	\$297.05
4WDB7-18SC-1	Tall Drawer with dividers	14" (356 mm) W x 21-5/8" (549 mm) D x 8" (203 mm) H	15" (381 mm)	B18	Maple	\$376.30
4WDB4-24SC-1	Standard Drawer	20" (508 mm) W x 21-5/8" (549 mm) D x 4-7/8" (124 mm) H	21" (533 mm)	B24	Maple	\$337.65
4WDB7-24SC-1	Tall Drawer with dividers	20" (508 mm) W x 21-5/8" (549 mm) D x 8" (203 mm) H	21" (533 mm)	B24	Maple	\$433.85



4PIL-18SC-2

- Designed for 18" (14-1/4" minimum cabinet opening) and 24" (20-1/4" minimum cabinet opening) base cabinets
- Double and triple drawer options available
- Tall drawers feature peg board bottoms with (3,4) pegs and (6,8) metal dividers
- BLUMOTION soft-close slides
- Stackable for use in a pantry applications
- Easily adjustable drawer height locations for storing tall and short items
- TSCA Title VI compliant



For video visit:
rev-a-shelf.com/videos

NOTE: See page 166 to see the Pilaster System in a base application



4PIL-18SC-3
Pilaster System Kit
(2) Standards, (1) Tall and brown finish shown)



4PIL-24SC-SV-2
Pilaster System Kit
(1) Standards, (1) Tall and Silver finish shown)



4WDB7-PIL-24SC-1
Tall Drawer w/ Dividers
(24" Version Shown)



4WDB4-PIL-18SC-1
Standard Drawer
(18" Version Shown)

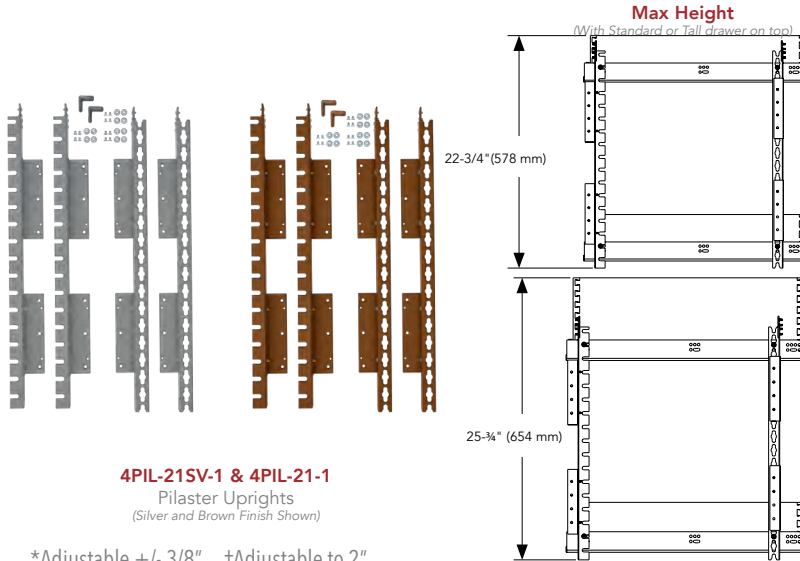

4PIL-21SV-1 & 4PIL-21-1
Pilaster Uprights
(Silver and Brown Finish Shown)

*Adjustable +/- 3/8". †Adjustable to 2".



4PIL-BUTTON-1
Pilaster Slide
Attachment Buttons



Pilaster System Kits w/ BLUMOTION Soft-Close - Slides and Uprights - Silver

PRODUCT	DESCRIPTION	DIMS	MCO	CAB	FINISH	SLP
4PIL-18SC-SV-2	(1) Standard, (1) Tall w/ Dividers	16-5/16" (567 mm) W* x 21-5/8" (549 mm) D x 21-1/4" (540 mm) H	14-1/4" (362 mm)	B18	Maple	\$581.65
4PIL-18SC-SV-3	(2) Standard, (1) Tall w/ Dividers	16-5/16" (567 mm) W* x 21-5/8" (549 mm) D x 22-3/4" (578 mm) H	14-1/4" (362 mm)	B18	Maple	\$786.35
4PIL-24SC-SV-2	(1) Standard, (1) Tall w/ Dividers	22-5/16" (567 mm) W* x 21-5/8" (549 mm) D x 21-1/4" (540 mm) H	18-1/4" (463 mm)	B24	Maple	\$649.35
4PIL-24SC-SV-3	(2) Standard, (1) Tall w/ Dividers	22-5/16" (567 mm) W* x 21-5/8" (549 mm) D x 23-3/4" (603 mm) H	18-1/4" (463 mm)	B24	Maple	\$877.25

Pilaster System Kits -w/ BLUMOTION Soft-Close - Slides and Uprights - Brown

4PIL-18SC-2	(1) Standard, (1) Tall w/ Dividers	16-5/16" (567 mm) W* x 21-5/8" (549 mm) D x 21-1/4" (540 mm) H	14-1/4" (362 mm)	B18	Maple	\$584.40
4PIL-18SC-3	(2) Standard, (1) Tall w/ Dividers	16-5/16" (567 mm) W* x 21-5/8" (549 mm) D x 22-3/4" (578 mm) H	14-1/4" (362 mm)	B18	Maple	\$790.00
4PIL-24SC-2	(1) Standard, (1) Tall w/ Dividers	22-5/16" (567 mm) W* x 21-5/8" (549 mm) D x 21-1/4" (540 mm) H	18-1/4" (463 mm)	B24	Maple	\$649.20
4PIL-24SC-3	(2) Standard, (1) Tall w/ Dividers	22-5/16" (567 mm) W* x 21-5/8" (549 mm) D x 23-3/4" (603 mm) H	18-1/4" (463 mm)	B24	Maple	\$881.45

Pilaster Kits -Uprights Only

4PIL-21-SV-1	Pilaster Upright Kit	1" (25 mm) W† x 1" (25 mm) D x 21" (533 mm) H			Silver	\$81.00
4PIL-21-SV-10	(10) Pilaster Upright Kits				Silver	\$60.25 ea.
4PIL-21-1	Pilaster Upright Kit	1" (25 mm) W† x 1" (25 mm) D x 21" (533 mm) H			Brown	\$81.00
4PIL-21-10	(10) Pilaster Upright Kits				Brown	\$60.25 ea.

Pilaster Buttons

4PIL-BUTTON-1	Pilaster upright button kit for slide attach (1 set of 4 buttons)				Silver	\$5.85
4PIL-BUTTON-12	Pilaster upright buttons for slide attach (12 sets of 4 buttons)				Silver	\$2.35 ea.

Drawer Box w/ BLUMOTION Soft-Close

PRODUCT	DESCRIPTION	DIMS	MCO	BC	FINISH	SLP
4WDB4-PIL-18SC-1	(1) Standard drawer	13-3/8" (340 mm) W x 21" (533 mm) D x 4" (102 mm) H (drawers only)	13-3/4" (349 mm)	B18	Maple	\$251.50
4WDB7-PIL-18SC-1	(1) Tall drawer w/ dividers	13-3/8" (340 mm) W x 21" (533 mm) D x 7" (178 mm) H (drawers only)	13-3/4" (349 mm)	B18	Maple	\$330.85
4WDB4-PIL-24SC-1	(1) Standard drawer for 24"	19-3/8" (492 mm) W x 21" (533 mm) D x 4" (102 mm) H (drawers only)	19-3/4" (502 mm)	B24	Maple	\$278.05
4WDB7-PIL-24SC-1	(1) Tall drawer w/ dividers	19-3/8" (567 mm) W x 21" (533 mm) D x 7" (178 mm) H (drawers only)	19-3/4" (502 mm)	B24	Maple	\$373.70

4FSCO Series

Food Storage Container Organizer



- Design for 18" and 24" base cabinets
- Natural maple dovetail construction with semi-gloss finish
- Adjustable clip-on lid dividers (5 w/18") (8 w/24")
- (7) customizable chrome "U" pegs
- Full-extension with over-travel, MOVENTO slides
- Mount to cabinet floor
- TSCA Title VI compliant

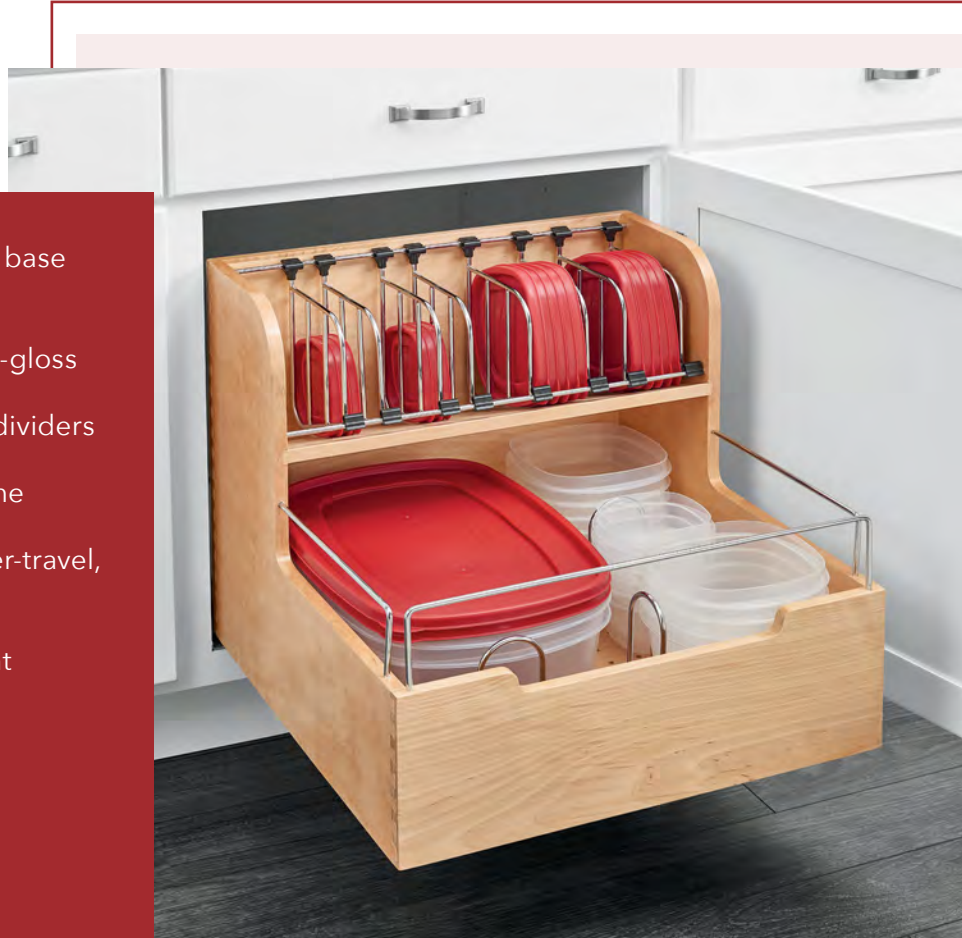

Base Solutions

4FSCO-24SC-1



4FSCO-18SC-1
Food Storage Container Organizer
(18" Version shown)



Clip-on lid dividers

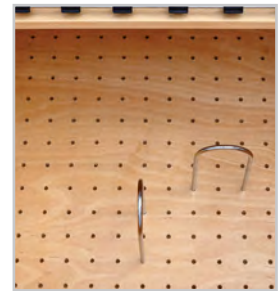

Versatile peg board with (7) Chrome "U" pegs



For video visit:
rev-a-shelf.com/videos

Food Storage Container Organizer w/ MOVENTO Soft-Close

PRODUCT	DESCRIPTION	DIMS	MCO	CAB	FINISH	SLP
4FSCO-18SC-1	Food Storage Container Organizer	14-1/2" (368 mm) W x 22-1/4" (565 mm) D x 18-7/8" (479 mm) H	14-1/2" (368 mm)	B18	Maple	\$431.65
4FSCO-24SC-1	Food Storage Container Organizer	20-1/2" (521 mm) W x 22-1/4" (565 mm) D x 18-7/8" (479 mm) H	20-1/2" (521mm)	B24	Maple	\$468.85



- Designed for 3", 6" and 9" base filler applications
- Natural maple construction with semi-gloss finish
- (2) slide configurations:
 - Full-extension, ball-bearing slides
 - Full extension slides with ball-bearing soft-close
- Adjustable shelves with chrome rails
- 3-slide design for 6" filler
- Create a functional storage space behind decorative panels
- TSCA Title VI compliant

432-BFBBSC-3C



432-BF-3C
Base Cabinet Filler
(3" version shown)



432-BFBBSC-6C
Base Cabinet Filler
w/ Ball-Bearing Soft-Close
(6" version shown)

NOTE: See page 234 wall cabinet version

Base Solutions

Base Cabinet Filler w/ Ball-Bearing Soft-Close

PRODUCT	DESCRIPTION	DIMS	FINISH	SLP
432-BFBBSC-3C	3" Base Filler Organizer	3" (76 mm) W x 23" (584 mm) D x 30" (762 mm) H	Maple	\$226.45
432-BFBBSC-6C	6" Base Filler Organizer	6" (152 mm) W x 23" (584 mm) D x 30" (762 mm) H	Maple	\$272.00

Base Cabinet Filler

432-BF-3C	3" Base Filler Organizer	3" (76 mm) W x 23" (584 mm) D x 30" (762 mm) H	Maple	\$177.05
432-BF-6C	6" Base Filler Organizer	6" (152 mm) W x 23" (584 mm) D x 30" (762 mm) H	Maple	\$215.05
432-BF-9C	9" Base Filler Organizer	9" (229 mm) W x 23" (584 mm) D x 30" (762 mm) H	Maple	\$293.55

432 SERIES

BLUMOTION® Base Cabinet Filler



- Designed for 3", 6" and 9" base filler applications
- Natural maple construction with semi-gloss finish
- BLUMOTION soft-close slides
- Adjustable shelves with chrome rails
- Middle shelf is solid for extra support
- Create a functional storage space behind those decorative panels
- TSCA Title VI compliant

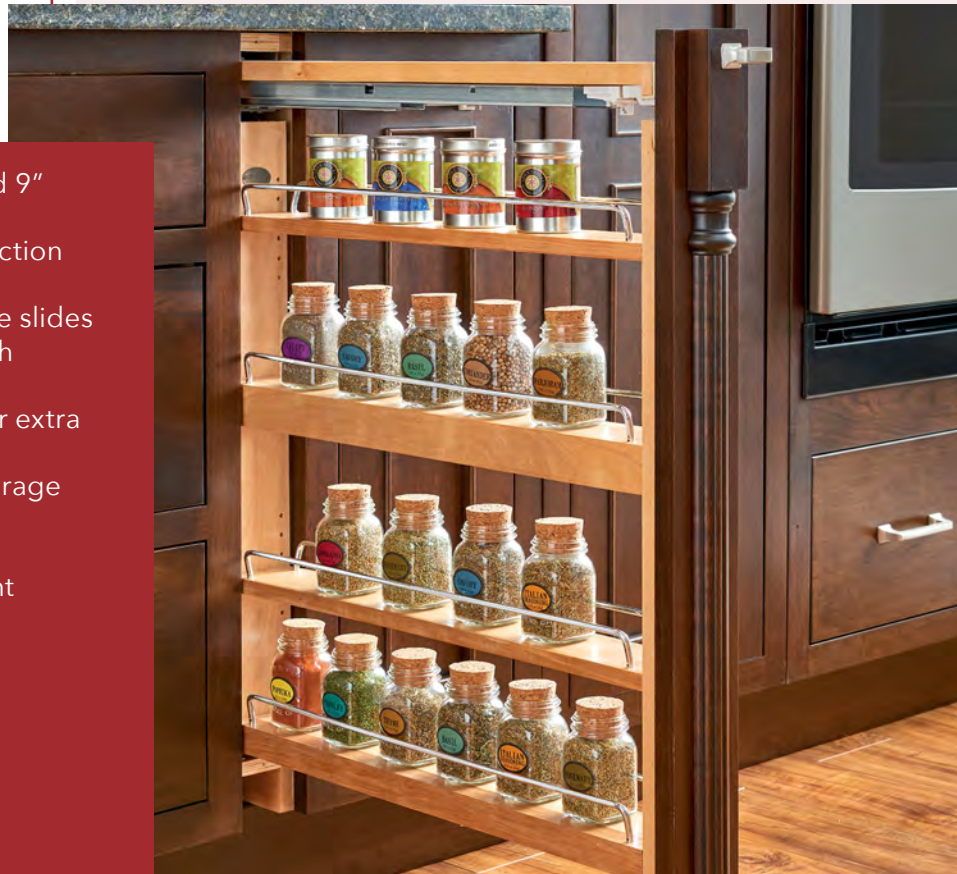

Base Solutions

432-BFSC-3C



432-BFSC-6C
Base Cabinet Filler
(6" version shown)



432-BFSC-9C
Base Cabinet Filler
(9" version shown)

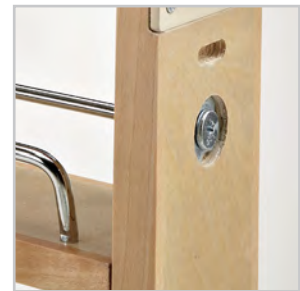

Jack screw for door micro-adjustments

Base Cabinet Filler w/ BLUMOTION Soft-Close

PRODUCT	DESCRIPTION	DIMS	FINISH	SLP
432-BFSC-3C	3" Base Filler Organizer	3" (76 mm) W x 23" (584 mm) D x 30" (762 mm) H	Maple	\$298.15
432-BFSC-6C	6" Base Filler Organizer	6" (152 mm) W x 23" (584 mm) D x 30" (762 mm) H	Maple	\$347.80
432-BFSC-9C	9" Base Filler Organizer	9" (229 mm) W x 23" (584 mm) D x 30" (762 mm) H	Maple	\$428.45



- Designed for 9" base filler applications
- One side features adjustable 2-3/4" wide shelves
- Opposite side features magnetic grade stainless steel panel
- (2) slide configurations:
 - Full-extension, ball-bearing slides
 - Full-extension, ball-bearing slides with soft-close
- Adjustable accessory hooks included
- Additional accessory hooks can be purchased separately (pg. 143)
- TSCA Title VI compliant

433-BF-9C



Magnetic grade stainless steel panel



433-BFBBSC-9C
Hybrid base cabinet filler w/ customizable accessory hooks

Hybrid Base Cabinet Filler

PRODUCT	DESCRIPTION	DIMS	FINISH	SLP
433-BF-9C	9" Base Filler Organizer	9" (229 mm) W x 23" (584 mm) D x 30" (762 mm) H	Maple	\$481.70
433-BFBBSC-9C	9" Base Filler Organizer w/Soft-Close	9" (229 mm) W x 23" (584 mm) D x 30" (762 mm) H	Maple	\$534.20



434-BFBBSC-3SS

- Designed for 3" and 6" base filler applications
- (2) slide configurations:
 - Full-extension, 100 lb. rated ball-bearing slides with soft-close
 - Full extension ball-bearing slides
- Magnetic grade stainless steel panel
- Variety of accessory hooks and pegs included
- Additional accessory hooks can be purchased separately
- TSCA Title VI compliant

NOTE: See page 244 wall cabinet version



Sewing application



Magnetic grade stainless steel panel



434-BF-3C
Base Cabinet Filler
(3" version shown)



434-BCSC-6C
Base Cabinet Filler w/ Soft-Close
(6" version shown)



434-S3-5
3" Single Hook

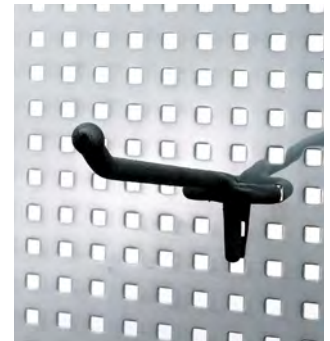

434-S6-5
6" Single Hook



434-D3-5
3" Double Hook



434-D6-5
6" Double Hook



434-PEG3-6
3" Peg



434-PEG6-6
6" Peg

Base Cabinet Filler w/ Stainless Steel Panel and Ball-Bearing Soft-Close

PRODUCT	DESCRIPTION	DIMS	FINISH	SLP
434-BFBBSC-3SS	3" Base Filler Organizer	3" (76 mm) W x 23" (584 mm) D x 30" (762 mm) H	Maple	\$369.05
434-BFBBSC-6SS	6" Base Filler Organizer	6" (152 mm) W x 23" (584 mm) D x 30" (762 mm) H	Maple	\$449.35

Base Cabinet Filler w/ Stainless Steel Panel

434-BF-3SS	3" Base Filler Organizer	3" (76 mm) W x 23" (584 mm) D x 30" (762 mm) H	Maple	\$349.50
434-BF-6SS	6" Base Filler Organizer	6" (152 mm) W x 23" (584 mm) D x 30" (762 mm) H	Maple	\$396.65

Bulk Accessories

434-S3-5	(5) 3" Single Hook			\$3.10 ea.
434-D3-5	(5) 3" Double Hook			\$4.40 ea.
434-Peg3-6	(6) 3" Peg			\$3.80 ea.
434-S6-5	(5) 6" Single Hook			\$3.40 ea.
434-D6-5	(5) 6" Double Hook			\$4.85 ea.
434-Peg6-6	(6) 6" Peg			\$5.15 ea.



- Designed for full height 6" and 9" base cabinets
- Fully assembled natural maple construction with chrome accents
- (2) slide configurations:
 - Full-extension, ball-bearing, 100 lb. rated slides
 - Full-extension, 110 lb. rated, concealed slides with BLUMOTION soft-close
- Trimmable to 26-3/8" height for custom cabinets
- Adjustable shelves
- Designed with top slide for complete stability
- TSCA Title VI compliant

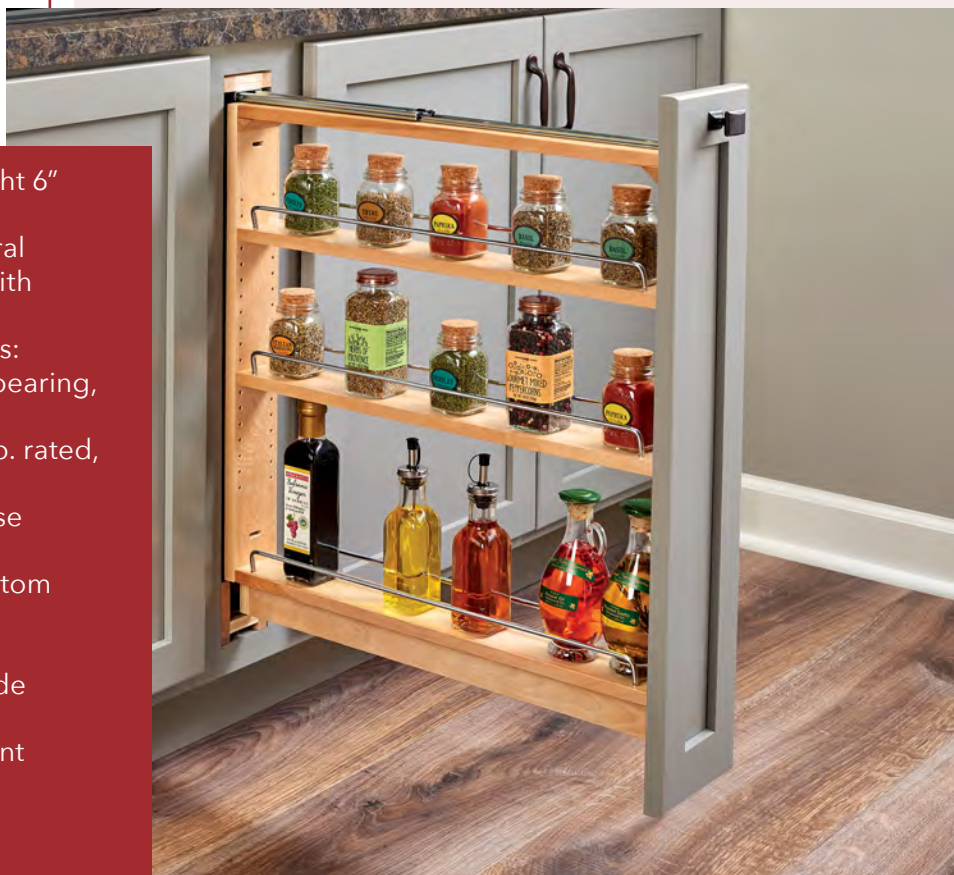

438-BC-3C



438-BCSC-6C
Base Organizer
(6" version shown)

NOTE: Our customers asked... so we delivered! We took the best features of our 448 Series Base Organizers and our 432 Series Filler Organizers and created this product specifically for use in full height base 6 and 9 cabinets.

Base Organizer

PRODUCT	DESCRIPTION	DIMS	MCO	CAB	FINISH	SLP
438-BC-3C	Base Organizer for 6"	3" (76 mm) W x 23" (584 mm) D x 27-5/16" (686 mm) H	3" (76 mm)	FHB6	Maple	\$157.35
438-BC-6C	Base Organizer for 9"	6" (153 mm) W x 23"(584 mm) D x 27-5/16" (686 mm) H	6" (152 mm)	FHB9	Maple	\$225.05

Base Organizer w/ BLUMOTION Soft-Close

438-BCSC-3C	Base Organizer for 6"	3" (76 mm) W x 23" (584 mm) D x 27-5/16" (686 mm) H	3" (76 mm)	FHB6	Maple	\$360.20
438-BCSC-6C	Base Organizer for 9"	6" (153 mm) W x 23"(584 mm) D x 27-5/16" (686 mm) H	6" (152 mm)	FHB9	Maple	\$439.10

Base Cabinet Pullout w/ Stainless Steel Panel

444 Series



- Designed for 12" full height base cabinets
- Natural maple construction with a semi-gloss finish
- (2) slide configurations:
 - Full-extension, ball-bearing, 100 lb. rated slides
 - Full-extension, 110 lb. rated, concealed slides with BLUMOTION soft-close
- Features a magnetic grade stainless steel panel and an array of accessory hooks
- Patented door mount brackets provide 5" of adjustability (US Patent No: 8,388,076)
- Adjustable rub bushings
- Additional accessory hooks can be purchased separately, (pg. 143)
- TSCA Title VI compliant

Base
Solutions

444-BCSC-8SS



Magnetic grade stainless steel panel



444-BCSC-8SS
Base Organizer w/ BLUMOTION
Soft-Close

NOTE: See page 245 wall cabinet version

Base Cabinet Pullout Organizer w/ Stainless Steel Panel

PRODUCT	DESCRIPTION	DIMS	MCO	CAB	FINISH	SLP
444-BC-8SS	Base Organizer	8" (202 mm) W x 22-1/2" (569 mm) D x 25-1/2" (648 mm) H	9" (229 mm)	FHB12	Maple	\$418.70

Base Organizer w/ Stainless Steel Panel and BLUMOTION Soft-Close

444-BCSC-8SS	Base Organizer	8" (203 mm) W x 21-9/16" (550 mm) D x 25-1/2" (648 mm) H	9" (229 mm)	FHB12	Maple	\$566.05
--------------	----------------	--	-------------	-------	-------	----------



448-BCBBS-8C

All Units:

- Natural maple construction with a semi-gloss finish
- Adjustable shelves with chrome rails
- Patented door mount brackets provide 5" of adjustability (US Patent No: 8,388,076)
- TSCA Title VI compliant

Soft-Close Units:

- Designed for 9" and 12" full height face frame base cabinets
- Full Extension, 150 lb. rated, ball-bearing slides with soft-close
- Adjustable rub bushings

Ball-Bearing Units:

- Designed for 9", 12", 15" and 18" full height face frame base cabinets, and 9" full height frameless cabinets
- Patented "tri-slides" which minimize any side-to-side motion (US Patent No. 7,306,301)

NOTE: See page 226 wall cabinet version

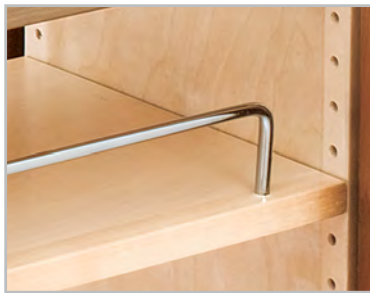

Adjustable shelves

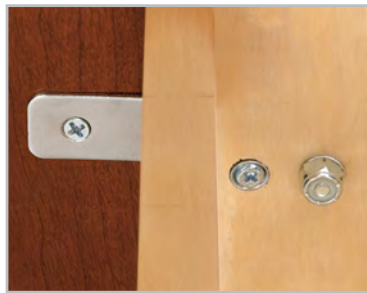

Adjustable door mount brackets (US Patent No: 8,388,076) and jack screw for precise door alignment



Adjustable rear wall



448-BC-8C
Base Cabinet Pullout
(8" version shown)



448-BCBBS-5C
Base Cabinet Pullout w/ Soft-Close
(5" version shown)



Adjustable threaded rub bushings included for custom applications.

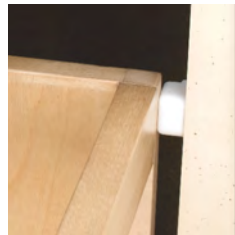

Plastic rub bushings included for 1.5" and 1.75" face frames applications.



For inset applications we recommend our IDRB bushing. The discreet design prevents side to side movement and fits behind the frame eliminating the need for surface drilling-giving you a seamless look and unparalleled stability.



448-08SC-SRI-1
Spice Rack Insert
(448-BCBBS-8C version shown)
Sold separately

Base Cabinet Pullout w/ Ball-Bearing Soft-Close

PRODUCT	DESCRIPTION	DIMS	MCO	CAB	FINISH	SLP
448-BCBBS-5C	Base Organizer	5" (127 mm) W x 21-3/4" (553 mm) D x 25-1/2"-29-1/2" (648-750 mm) H	5-1/2" (140 mm)	FHB9	Maple	\$278.70
448-BCBBS-8C	Base Organizer	8" (203 mm) W x 21-3/4" (553 mm) D x 25-1/2"-29-1/2" (648-750 mm) H	8-1/2" (216 mm)	FHB12	Maple	\$294.55

Base Cabinet Pullout

448-BC-5C	Base Organizer	5" (127 mm) W x 22-1/2" (571 mm) D x 25-1/2" (647 mm) H	5-1/2" (140 mm)	FHB9	Maple	\$207.15
448-BC-6C	Frameless Organizer	6.5" (165 mm) W x 22-1/2" (571 mm) D x 25-1/2" (647 mm) H	7" (178 mm)	FHB9	Maple	\$211.20
448-BC-8C	Base Organizer	8" (202 mm) W x 22-1/2" (571 mm) D x 25-1/2" (647 mm) H	8-1/2" (216 mm)	FHB12	Maple	\$237.50
448-BC-11C	Base Organizer	11" (280 mm) W x 22-1/2" (571 mm) D x 25-1/2" (647 mm) H	11-1/2" (292 mm)	FHB15	Maple	\$364.20
448-BC-14C	Base Organizer	14" (356 mm) W x 22-1/2" (571 mm) D x 25-1/2" (647 mm) H	14-1/2" (368 mm)	FHB18	Maple	\$431.95

Spice Rack Insert for Base Cabinet Pullout

448-08SC-SRI-1	For 448-BCBBS-8C	7" (178 mm) W x 19-1/2" (495 mm) D x 4-7/8" (124 mm) H			Maple	\$79.95
448-SR8-1	For 448-BC-8C	7" (178 mm) W x 21" (534 mm) D x 4-7/8" (124 mm) H			Maple	\$49.05
448-SR11-1	For 448-BC-11C	10" (254 mm) W x 21" (534 mm) D x 4-7/8" (124 mm) H			Maple	\$62.65

Accessories

IDRB-1	Adjustable Rub Bushing for Inset Applications				Metal	\$13.25
--------	---	--	--	--	-------	---------

NOTE: Minimum Cabinet Openings with rub bushings are 1/2" smaller



- Designed for full access 9" and 12", face frame 9", 12", 15" and 18" full height and 9", 12" and 15" drawer/door base cabinets
- Natural maple construction with semi-gloss finish
- Full-extension slides with BLUMOTION soft-close
- Adjustable shelves with chrome rails
- Adjustable rub bushings
- Patented door mount brackets provide 5" of adjustability (US Patent No. 8,388,076)
- TSCA Title VI compliant

448-BCSC-8C & 448-08SC-SRI-1

448-BDDSC-11C
Drawer/DoorBase Cabinet Pullout
(11" version shown)



Adjustable threaded rub bushings included for custom applications.

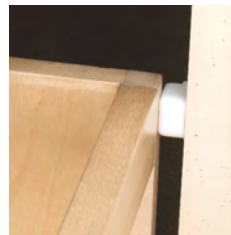

Plastic rub bushings included for 1.5" and 1.75" face frames applications.





448-08SC-SRI-1
Spice Rack
(7" version shown)
Sold separately



448-BCSC-8C
Base Cabinet Pullout for Full Height
(8" version shown)



448-BC19SC-5C
Base Cabinet Pullout, Reduced Depth
(5" version shown)



448-BCSC-9C
Base Cabinet Pullout for Full Access
(9" version shown)



448-BCSCSD-5C
Base Cabinet Pullout w/ SERVO-DRIVE
(5" version shown)



448-BDDSC-11C
Base Cabinet Pullout for Drawer/Door
(11" version shown)

* Reduced depth

Base Cabinet Pullout w/ BLUMOTION Soft-Close for Full Height						
PRODUCT	DESCRIPTION	DIMS	MCO	CAB	FINISH	SLP
448-BCSC-5C	Base Organizer	6" (152 mm) W x 21-5/8" (549 mm) D x 25-1/2" - 29-1/2" (648- 749 mm)	6" (155 mm)	FHB9	Maple	\$321.55
448-BC19SC-5C	Base Organizer*	6" (152 mm) W x 19-9/16" (497 mm) D x 25-1/2" (647 mm) H	6" (155 mm)	FHB9	Maple	\$326.25
448-BCSC-8C	Base Organizer	8-3/4" (222 mm) W x 21-5/8" (549 mm) D x 25-1/2" - 29-1/2" (648- 749 mm)	9" (229 mm)	FHB12	Maple	\$357.35
448-BC19SC-8C	Base Organizer*	8-3/4" (222 mm) W x 19-9/16" (497 mm) D x 25-1/2" (647 mm) H	9" (229 mm)	FHB12	Maple	\$424.20
448-BCSC-11C	Base Organizer	11-3/4" (298 mm) W x 21-5/8" (549 mm) D x 25-1/2" - 29-1/2" (648- 749 mm) H	12" (305 mm)	FHB15	Maple	\$422.45
448-BCSC-14C	Base Organizer	14-3/4" (375 mm) W x 21-5/8" (549 mm) D x 25-1/2" - 29-1/2" (648- 749 mm) H	15" (381 mm)	FHB18	Maple	\$524.05
Full Access Base Cabinet Pullout w/ BLUMOTION Soft-Close						
448-BCSC-6C	Base Organizer	7-1/4" (184 mm) W x 21-5/8" (549 mm) D x 25-1/2" - 29-1/2" (648- 749 mm) H	7-1/2" (191 mm)	FLFHB9	Maple	\$341.30
448-BCSC-9C	Base Organizer	10-1/4" (260 mm) W x 21-5/8" (549 mm) D x 25-1/2" - 29-1/2" (648- 749 mm) H	10-1/2" (273 mm)	FLFHB12	Maple	\$403.70
Base Cabinet Pullout w/ BLUMOTION Soft-Close and SERVO-DRIVE						
448-BCSCSD-5C	Base Organizer	6" (152 mm) W x 22-3/4" - 24-1/4" (578-616 mm) D x 25-1/2" - 29-1/2" (648- 749 mm) H	6" (155 mm)	FHB9	Maple	\$883.05
448-BCSCSD-8C	Base Organizer	8" (203 mm) W x 22-3/4" - 24-1/4" (578-616 mm) D x 25-1/2" - 29-1/2" (648- 749 mm) H	9" (229 mm)	FHB12	Maple	\$925.50
Base Cabinet Pullout w/ BLUMOTION Soft-Close for Drawer/Door						
448-BDDSC-5C	Base Organizer	6" (152 mm) W x 21-5/8" (549 mm) D x 19-7/16 - 23-3/8" (494- 594 mm) H	6" (155 mm)	B9	Maple	\$276.10
448-BDDSC-8C	Base Organizer	8-3/4" (222 mm) W x 21-5/8" (549 mm) D x 19-7/16 - 23-3/8" (494- 594 mm) H	9" (229 mm)	B12	Maple	\$350.70
448-BDDSC-11C	Base Organizer	11-3/4" (298 mm) W x 21-5/8" (549 mm) D x 19-7/16 - 23-3/8" (494- 594 mm) H	12" (305 mm)	B15	Maple	\$403.30
Spice Rack Insert for Base Cabinet Pullout						
448-08SC-SRI-1	Spice Rack	7" (178 mm) W x 19-1/2" (534 mm) D x 4-7/8" (124 mm) H			Maple	\$79.95
448-11SC-SRI-1	Spice Rack	10" (254 mm) W x 19-1/2" (534 mm) D x 4-7/8" (124 mm) H			Maple	\$92.05

NOTE: Minimum Cabinet Openings with rub bushings are 1/2" smaller

448OXO Series

Base Cabinet Pullout w/ OXO Containers



448OXO-BCSC-8C

- Designed for 12" full height base cabinets
- Natural maple construction with semi-gloss finish
- Full-extension slides with BLUMOTION soft-close
- (7) BPA free OXO Good Grips POP containers
 - (3) 4.3 qt
 - (3) 1.7 qt
 - (1) 2.6 qt
- Adjustable rub bushings
- Patented door mount brackets (US Patent No. 8,388,076)
- TSCA Title VI compliant

Base Solutions



448OXO-BCSC-8C
Base Cabinet Pullout w/ OXO® Containers



Adjustable threaded rub bushings included for custom applications.



Plastic rub bushings included for 1.5" and 1.75" face frames applications.



For video visit:
rev-a-shelf.com/videos

Base Cabinet Pullout w/ OXO® Containers and BLUMOTION Soft-Close

PRODUCT	DESCRIPTION	DIMS	MCO	CAB	FINISH	SLP
448OXO-BCSC-8C	Base Organizer	8-3/4" (222 mm) W x 21-5/8" (549 mm) D x 25-1/2" - 29-1/2" (648- 749 mm)	9" (229 mm)	FHB12	Maple	\$731.90

NOTE: Minimum Cabinet Openings with rub bushings are 1/2" smaller

Base Cabinet Pullout w/ Utensil Bins

448UT Series



- Designed for 9" and 12" full height base cabinets
- Natural maple construction with semi-gloss finish
- Full-extension slides with BLUMOTION soft-close
- (3) 1.25 qt or (3) 2 qt. stainless steel bins
- Adjustable shelves and rear wall for added stability
- Adjustable rub bushings that prevent side to side movement
- Patented door mount brackets (US Patent No. 8,388,076)
- TSCA Title VI compliant

Base
Solutions

448UT-BCSC-5C



Adjustable threaded rub bushings included for custom applications.

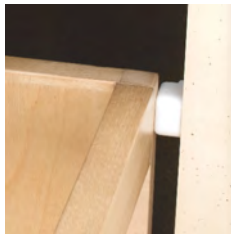

Plastic rub bushings included for 1.5" and 1.75" face frames applications.



448UT-BCSC-8C
Base Cabinet Pullout
w/Utensil Bins
(8" unit shown)



For video visit:
rev-a-shelf.com/videos

Base Cabinet Pullout w/ (3) Utensil Bins and BLUMOTION Soft-Close

PRODUCT	DESCRIPTION	DIMS	MCO	CAB	FINISH	SLP
448UT-BCSC-5C	Base Organizer	6" (152 mm) W x 21-5/8" (549 mm) D x 25-1/2" - 29-1/2" (648- 749 mm) H	6" (155 mm)	FHB9	Maple	\$395.30
448UT-BCSC-8C	Base Organizer	8-3/4" (222 mm) W x 21-5/8" (549 mm) D x 25-1/2" - 29-1/2" (648- 749 mm) H	9" (229 mm)	FHB12	Maple	\$447.60

NOTE: Minimum Cabinet Openings with rub bushings are 1/2" smaller



- Designed for 12" and 15" full height face frame base cabinets, and 12" full height full access cabinets
- Natural maple construction with a semi-gloss finish
- Full-extension slides with BLUMOTION soft-close
- (1) 2 qt. or (2) 2 qt. and (2) 1.25 qt. removable stainless steel bins
- Knife block features flex rod technology that adjust to securely hold knives
- (4) flexible plastic cutting mats (9" full access)
- Adjustable rear wall
- Adjustable accessory shelf and lower static shelf with chrome rails
- Patented door mount brackets provide 5" of adjustability (US Patent No: 8,388,076)
- TSCA Title VI Compliant

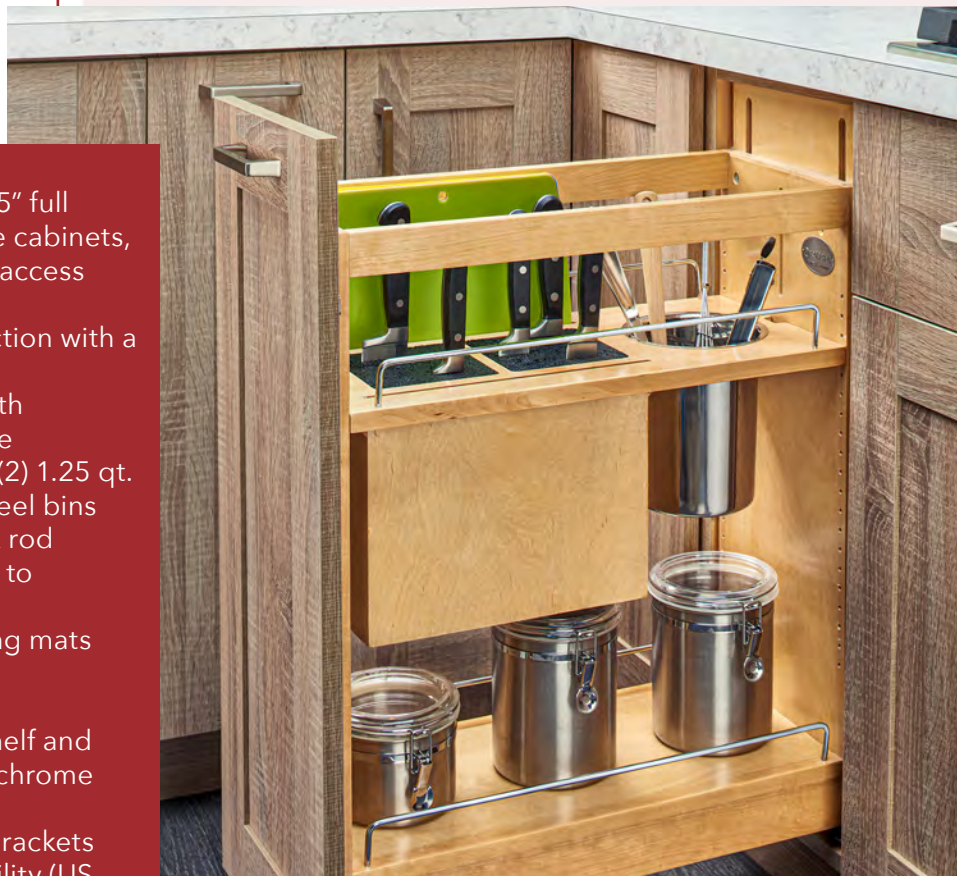

448KB-BCSC-8C



Adjustable threaded rub bushings included for custom applications.

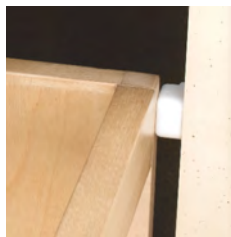

Plastic rub bushings included for 1.5" and 1.75" face frames applications.



448KB-BCSC-8C
Base Cabinet Pullout w/ Knife Block and Utensil Bins
(8" unit shown)



448KB-BCSC-11C
Base Cabinet Pullout w/ Knife Block and Utensil Bins
(11" unit shown)



Now with Flexible cutting mats (9" version only)



For video visit:
rev-a-shelf.com/videos

Base Cabinet Pullout w/ Knife Block and Utensil Bins w/ BLUMOTION Soft-Close

PRODUCT	DESCRIPTION	DIMS	MCO	CAB	FINISH	SLP
448KB-BCSC-8C	Base Organizer w/(1)Bin	8-3/4" (222 mm) W x 21-5/8" (549 mm) D x 25-1/2" - 29-1/2" (648- 749 mm) H	9" (229 mm)	FHB12	Maple	\$586.15
448KB-BCSC-11C	Base Organizer w/ (4)Bins	11-3/4" (298 mm) W x 21-5/8" (549 mm) D x 25-1/2" - 29-1/2" (648- 749 mm) H	12" (305 mm)	FHB15	Maple	\$700.10

Full Access Base Cabinet Pullout w/ Knife Block and Utensil Bins w/ BLUMOTION Soft-Close

448KB-BCSC-9C	Base Organizer w/(1)Bin	10-1/4" (260 mm) W x 21-5/8" (549 mm) D x 25-1/2" - 29-1/2" (648- 749 mm) H	10-1/4" (260 mm)	FLB12	Maple	\$669.60
---------------	-------------------------	---	------------------	-------	-------	----------

NOTE: Minimum Cabinet Openings with rub bushings are 1/2" smaller

Base Cabinet Pullout Tray Divider/Foil Wrap Holder

447 Series



blum

- Designed for 9" and 12" base cabinets
- Natural maple construction with semi-gloss finish
- Full-extension slides with BLUMOTION soft-close
- Removable center divider
- T-Bar divider for taller items
- Patented door mount brackets provide 5" of adjustability (US Patent No. 8,388,076)
- TSCA Title VI compliant

447-BCSC-8C

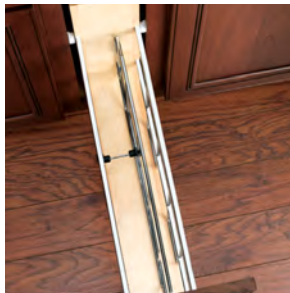

Included T-Bars allow you to customize your storage needs



447-BCSC-5C
Base Cabinet Pullout
w/Utensil Bins
(5" unit shown)



Adjustable threaded rub bushings included for custom applications.



Plastic rub bushings included for 1.5" and 1.75" face frames applications.

Base
Solutions

Base Cabinet Pullout Tray Divider/Foil Wrap Holder w/ BLUMOTION Soft-Close

PRODUCT	DESCRIPTION	DIMS	MCO	CAB	FINISH	SLP
447-BCSC-5C	Base Cabinet Pullout	6" (152 mm) W x 21-21/32" (550 mm) x 19-1/2" (495 mm) H	6" (155 mm)	B9	Maple	\$311.40
447-BCSC-8C	Base Cabinet Pullout	8-3/4" (222 mm) W x 21-21/32" (550 mm) x 19-1/2" (495 mm)H	9" (229 mm)	B12	Maple	\$357.00



449-BCSC-10C

- Designed for 9 and 12" full height base cabinets
 - Face Frame fit 1-3/4", 1-1/2" and 1-5/8"
 - Full Access fit 3/4" and 5/8"
- Natural maple construction with semi-gloss finish
- (2) adjustable shelves for base organizer and (1) adjustable shelf for utensil organizer with chrome accents
- Utensil organizer features (3) 1-1/4 qt. removable stainless-steel bins
- Full-extension, TANDEM, 110 lb. rated concealed slides with BLUMOTION soft-close
- Face frame version features patent pending foldable slide set for easy installation
- Mounts to cabinet door, floor and side
- Patented door mount brackets with micro-adjustments (US Patent No. 8,388,076)
- TSCA Title VI compliant



For video visit:
rev-a-shelf.com/videos



Full access slide location



Face frame slide location



(3) 1-1/4 qt. Removeable utensil bins in the Utensil Organizer



Spacer allows for multiple face frame sizes



Patent-pending face frame foldable slide set for easy installation



Adjustable "L" bracket for side mount



449-BCSC-5C
Side and Bottom Mount
Base Pullout
(5" version shown)



449-BCSC-7C
Full Access Side and Bottom Mount
Base Pullout
(7" version shown)



448-BCSC-8C
Side and Bottom Mount
Base Pullout
(8" version shown)



449UT-BCSC-7C
Full Access Side and Bottom Mount
Utensil Base Pullout
(7" version shown)

Passe Solutions

Side and Bottom Mount Base Pullout w/ BLUMOTION Soft-Close

PRODUCT	DESCRIPTION	DIMS	MCO	CAB	FINISH	SLP
449-BCSC-5C	Base Organizer	6-1/4" (158 mm) W x 21-3/4" (552 mm) D x 25-1/2" (647 mm) H	5-1/2" (140 mm)	FHB9	Maple	\$370.80
449-BCSC-8C	Base Organizer	9-1/4" (235 mm) W x 21-3/4" (552 mm) D x 25-1/2" (647 mm) H	8-1/2" (216 mm)	FHB12	Maple	\$423.15

Full Access Side and Bottom Mount Base Pullout w/ BLUMOTION Soft-Close

449-BCSC-7C	Base Organizer	7-1/2" (191 mm) W x 21-13/16" (554 mm) D x 25-1/4" (643 mm) H	7-1/2" (191 mm)	FLFHB9	Maple	\$358.85
449-BCSC-10C	Base Organizer	10-1/2" (267 mm) W x 21-13/16" (554 mm) D x 25-1/4" (643 mm) H	10-1/2" (267 mm)	FLFHB12	Maple	\$438.60

Side and Bottom Mount Utensil Base Pullout w/ BLUMOTION Soft-Close

449UT-BCSC-5C	Utensil Organizer	6-1/4" (158 mm) W x 21-3/4" (552 mm) D x 25-1/2" (647 mm) H	5-1/2" (140 mm)	FHB9	Maple	\$381.60
449UT-BCSC-8C	Utensil Organizer	9-1/4" (235 mm) W x 21-3/4" (552 mm) D x 25-1/2" (647 mm) H	8-1/2" (216 mm)	FHB12	Maple	\$431.55

Full Access Side and Bottom Mount Utensil Base Pullout w/ BLUMOTION Soft-Close

449UT-BCSC-7C	Utensil Organizer	7-1/2" (191 mm) W x 21-13/16" (554 mm) D x 25-1/4" (643 mm) H	7-1/2" (191 mm)	FLFHB9	Maple	\$370.20
449UT-BCSC-10C	Utensil Organizer	10-1/2" (267 mm) W x 21-13/16" (554 mm) D x 25-1/4" (643 mm) H	10-1/2" (267 mm)	FLFHB12	Maple	\$456.25



- Designed for 9" 12" and 15" face frame base cabinets and 9" and 12" full access base cabinets
- Solid bottom shelves with chrome-plated round wire, gray or natural maple or orion gray flat wire with textured linen finish
- Full-extension, 110 lb. rated slides with BLUMOTION soft-close
- 5322-BCSC-5 mounts to cabinet side wall
- 5322-BCSC-8 and 11 mount to cabinet floor
- Patented door mount brackets (US Patent No. 8,047,621)
- TSCA Title VI compliant

5322-BCSC-9-FOG



Designed in
cooperation with

SIGE
ACCESSORI IN FILLO METALLICO - WIRE PRODUCTS



For video visit:
rev-a-shelf.com/videos

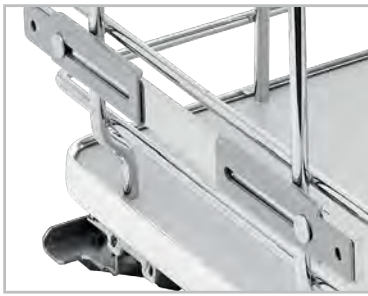

Features Rev-A-Shelf's patented AMB door mount brackets US Patent No. 7,204,569

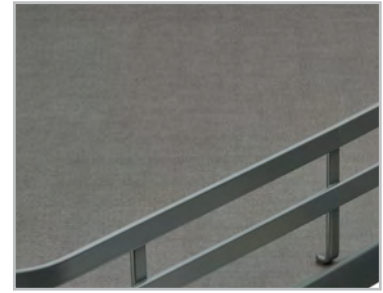
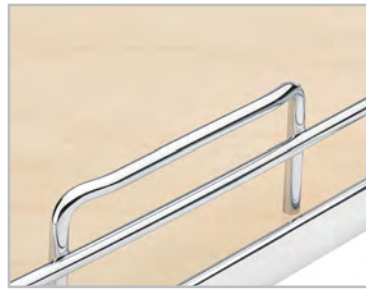

Solid bottom shelves in maple or gray, with chrome accents or orion gray with flat wire



5322-BCSC-5-MP
Face Frame
Contemporary Base Cabinet Pullout
(5" Maple version shown)
(Side mount only)



5322-BCSC-11-GR
Base Cabinet Pullout
w/ Soft-Close
(11" Gray version shown)



5322-BCSC-6-FOG
Contemporary Base Cabinet Pullout
(6" Orion Gray version shown)

Full Access Contemporary Base Cabinet Pullout w/ BLUMOTION Soft-Close

PRODUCT	DESCRIPTION	DIMS	MCO	CAB	FINISH	SLP
5322-BCSC-6-GR	Base Organizer	7-1/4" (183 mm) W x 21-11/16" (551 mm) D x 24" (609 mm) H	7-1/2" (191 mm)	FLFHB9	Gray	\$411.35
5322-BCSC-6-MP	Base Organizer	7-1/4" (183 mm) W x 21-11/16" (551 mm) D x 24" (609 mm) H	7-1/2" (191 mm)	FLFHB9	Maple	\$417.25
5322-BCSC-9-GR	Base Organizer	10-1/4" (260 mm) W x 21-11/16" (551 mm) D x 24" (609 mm) H	10-1/2" (267 mm)	FLFHB12	Gray	\$424.80
5322-BCSC-9-MP	Base Organizer	10-1/4" (260 mm) W x 21-11/16" (551 mm) D x 24" (609 mm) H	10-1/2" (267 mm)	FLFHB12	Maple	\$430.30
5322-BCSC-6-FOG	Base Organizer	7-1/4" (184 mm) W x 21-11/16" (551 mm) D x 24" (609 mm) H	7-1/2" (191 mm)	FLFHB9	Orion Gray	\$452.80
5322-BCSC-9-FOG	Base Organizer	10-1/4" (260 mm) W x 21-11/16" (551 mm) D x 24" (609 mm) H	10-1/2" (267 mm)	FLFHB12	Orion Gray	\$461.20

Face Frame Contemporary Base Cabinet Pullout w/ BLUMOTION Soft-Close

5322-BCSC-5-GR	Base Organizer	6" (152 mm) W x 22-1/8" (562 mm) D x 24-1/2" (622 mm) H	6" (152 mm)	FFFHB9	Gray	\$386.30
5322-BCSC-5-MP	Base Organizer	6" (152 mm) W x 22-1/8" (562 mm) D x 24-1/2" (622 mm) H	6" (152 mm)	FFFHB9	Maple	\$392.95
5322-BCSC-8-GR	Base Organizer	8" (213 mm) W x 21-11/16" (551 mm) D x 24" (609 mm) H	9" (229 mm)	FFFHB12	Gray	\$456.40
5322-BCSC-8-MP	Base Organizer	8" (213 mm) W x 21-11/16" (551 mm) D x 24" (609 mm) H	9" (229 mm)	FFFHB12	Maple	\$463.65
5322-BCSC-11-GR	Base Organizer	11-3/4" (298 mm) W x 21-11/16" (551 mm) D x 24" (609 mm) H	12" (305 mm)	FFFHB15	Gray	\$480.65
5322-BCSC-11-MP	Base Organizer	11-3/4" (298 mm) W x 21-11/16" (551 mm) D x 24" (609 mm) H	12" (305 mm)	FFFHB15	Maple	\$485.70

Contemporary Base Cabinet Pullout w/ Knife Block & Utensil Bin



- Designed for 9" full access cabinets and 12" and 15" full access and face frame base cabinets
- Solid bottom shelves with chrome-plated round wire, gray or natural maple or orion gray flat wire and textured linen finish
- Full-extension, 110 lb. rated slides with BLUMOTION soft-close
- (1) 2 qt. or (2) 2 qt. and (2) 1.25 qt. removable stainless steel bins
- Patented door mount brackets (US Patent No. 8,047,621)
- Knife block features flex rod technology that adjust to securely hold knives
- TSCA Title VI compliant

5322KB-BCSC-6-FOG



For video visit:
rev-a-shelf.com/videos

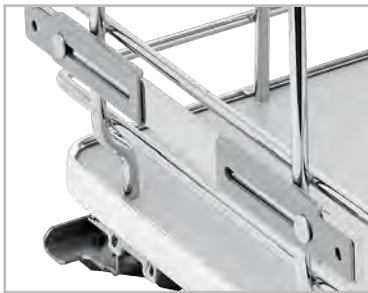

Features Rev-A-Shelf's patented AMB door mount brackets US Patent No. 7,204,569



Solid bottom shelves in maple or gray, with chrome accents or orion gray with flat wire



5322KB-BCSC-6-MP
Face Frame
Contemporary Base Cabinet Pullout
(6" Maple version shown)



5322-BCSC-11-GR
Base Cabinet Pullout
w/ Soft-Close
(11" Gray version shown)



5322KB-BCSC-6-FOG
Contemporary Base Cabinet Pullout
(6" Orion Gray version shown)

Full Access Contemporary Base Cabinet Pullout w/ BLUMOTION Soft-Close

PRODUCT	DESCRIPTION	DIMS	MCO	CAB	FINISH	SLP
5322KB-BCSC-6-GR	Base Organizer w/(1) Bin	7-1/4" (183 mm) W x 21-11/16" (551 mm) D x 24" (609 mm) H	7-1/2" (191 mm)	FLFHB9	Gray	\$772.10
5322KB-BCSC-6-MP	Base Organizer w/(1) Bin	7-1/4" (183 mm) W x 21-11/16" (551 mm) D x 24" (609 mm) H	7-1/2" (191 mm)	FLFHB9	Maple	\$777.75
5322KB-BCSC-9-GR	Base Organizer w/ (1) Bin	10-1/4" (259 mm) W x 21-11/16" (551 mm) D x 24" (609 mm) H	10-1/2" (267 mm)	FLFHB12	Gray	\$789.10
5322KB-BCSC-9-MP	Base Organizer w/ (1) Bin	10-1/4" (259 mm) W x 21-11/16" (551 mm) D x 24" (609 mm) H	10-1/2" (267 mm)	FLFHB12	Maple	\$794.60
5322KB-BCSC-6-FOG	Base Organizer w/ (1)Bin	7-1/4" (184 mm) W x 21-11/16" (551 mm) D x 24" (609 mm) H	7-1/2" (191 mm)	FLFHB9	Orion Gray	\$720.35

Face Frame Contemporary Base Cabinet Pullout w/ BLUMOTION Soft-Close

5322KB-BCSC-8-GR	Base Organizer w/ (1) Bin	8-3/4" (222 mm) W x 21-11/16" (551 mm) D x 24" (609 mm) H	9" (229 mm)	FFFHB12	Gray	\$651.35
5322KB-BCSC-8-MP	Base Organizer w/ (1) Bin	8-3/4" (222 mm) W x 21-11/16" (551 mm) D x 24" (609 mm) H	9" (229 mm)	FFFHB12	Maple	\$667.15
5322KB-BCSC-11-GR	Base Organizer w/ (4) Bins	11-3/4" (298 mm) W x 21-11/16" (551 mm) D x 24" (609 mm) H	12" (305 mm)	FFFHB15	Gray	\$715.70
5322KB-BCSC-11-MP	Base Organizer w/ (4) Bins	11-3/4" (298 mm) W x 21-11/16" (551 mm) D x 24" (609 mm) H	12" (305 mm)	FFFHB15	Maple	\$723.10

Contemporary Base Cabinet Pullout w/ Utensil Bins



- Designed for 12" base cabinets
- Solid bottom shelves with chrome-plated round wire, gray or natural maple or orion gray flat wire and textured linen finish
- Full-extension, 110 lb. rated slides with BLUMOTION soft-close
- (3) 2 qt. or (3) 1.25 qt. removable stainless steel bins
- Patented door mount brackets (US Patent No. 8,047,621)
- TSCA Title VI compliant

5322UT-BCSC-6-FOG



For video visit:
rev-a-shelf.com/videos



Features Rev-A-Shelf's patented AMB door mount brackets US Patent No. 7,204,569



Solid bottom shelves in maple or gray, with chrome accents or orion gray with flat wire



5322UT-BCSC-8-MP
Face Frame
Contemporary Base Cabinet Pullout
(8" Maple version shown)



5322UT-BCSC-8-GR
Base Cabinet Pullout
w/ Soft-Close
(8" Gray version shown)



5322UT-BCSC-6-FOG
Contemporary Base Cabinet Pullout
(6" Orion Gray version shown)

Full Access Contemporary Base Cabinet Pullout w/ (3) Utensil Bins and BLUMOTION Soft-Close

PRODUCT	DESCRIPTION	DIMS	MCO	CAB	FINISH	SLP
5322UT-BCSC-6-GR	Base Organizer	7-1/4" (183 mm) W x 21-11/16" (551 mm) D x 24" (610 mm) H	7-1/2" (191 mm)	FLFHB9	Gray	\$501.65
5322UT-BCSC-6-MP	Base Organizer	7-1/4" (183 mm) W x 21-11/16" (551 mm) D x 24" (610 mm) H	7-1/2" (191 mm)	FLFHB9	Maple	\$510.35
5322UT-BCSC-6-FOG	Base Organizer	7-1/4" (184 mm) W x 21-11/16" (551 mm) D x 24" (609 mm) H	7-1/2" (191 mm)	FLFHB9	Orion Gray	\$523.70

Face Frame Contemporary Base Cabinet Pullout w/ (3) Utensil Bins and BLUMOTION Soft-Close

5322UT-BCSC-8-GR	Base Organizer	8-3/4" (222 mm) W x 21-11/16" (551 mm) D x 24" (609 mm) H	9" (229 mm)	FFFHB12	Gray	\$500.95
5322UT-BCSC-8-MP	Base Organizer	8-3/4" (222 mm) W x 21-11/16" (551 mm) D x 24" (609 mm) H	9" (229 mm)	FFFHB12	Maple	\$507.90

5375 Series

Wine Base Cabinet Organizer



- Designed for a 15" minimum cabinet opening
- Chrome-plated round wire
- Gas spring assist soft-open/soft-close
- Holds (20) wine bottles, 150 lb. capacity
- Patented door mount brackets (US Patent No. 8,047,621)
- Universal for left or right handed cabinets



5375-40WR-1CR



5375-40WR-1CR
Wine Base Cabinet Pullout



Wine Base Organizer w/ Soft-Close

PRODUCT	DESCRIPTION	DIMS	MCO	CAB	FINISH	SLP
5375-40WR-1CR	Wine Base Organizer	14-1/8" (356 mm) W x 17" (432 mm) D x 25-3/4" (654 mm) H	15" (381 mm)	FHB18	Chrome	\$632.90

Chrome Base Pullout

5225 Series



- Designed for 12" base cabinets
- Solid bottom shelves with chrome-plated round wire and Stylinox™ anti-skid, maple
- Full-extension, 250 lb. rated slides with soft-close
- Built-in door mount brackets included
- TSCA Title VI compliant



Chrome Base Pullout w/ (3) Maple Shelves

PRODUCT	DESCRIPTION	DIMS	MCO	CAB	FINISH	SLP
5225-09-MP	Chrome Base Pullout	8-5/8" (226 mm) W x 26-3/8"-35" (670-890 mm) D x 20" (508 mm)	9" (229 mm)	FHB12	Maple	\$1,063.45



548 Series

- Designed for use in both 12" full height or drawer/door cabinet applications
- (2) adjustable polymer shelves with chrome accents
- Ball-bearing, patented tri-slide system
- Patented door mounting system (US Patent No: 7,204,569)

Chrome Base Pullout w/ (3) Polymer Shelves

PRODUCT	DESCRIPTION	DIMS	MCO	CAB	FINISH	SLP
548-BC-8C	Chrome Base Pullout	7-7/8" (200 mm) W x 22-1/2" (572 mm) D x 19-1/4" (489 mm) H	9" (229 mm)	B12	Chrome	\$169.95



- Designed for 15", 18", 24" and 36" base cabinets
- Chrome-plated round wire
- Full-extension, under mount slides with soft-close
- Adjustable mounting brackets
- Door mount brackets included

5730-21CR

MOUNTING BRACKET OPTIONS

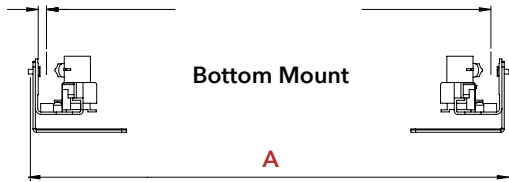

Bottom Mount

A



Side Mount
No Spacers

B

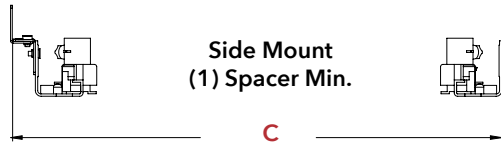

Side Mount
(1) Spacer Min.

C

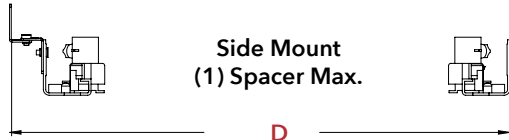

Side Mount
(1) Spacer Max.

D



Side Mount
(2) Spacers Min.

E



Side Mount
(2) Spacers Max.

F



Create a customized space for pots, pans and lids with the new Chrome Wire Drop In Cookware Organizer, compatible with 21" and 33" pullout shelves



5730-12CR
Pullout Wire Shelf
(12" version shown)



5730-15CR
Pullout Wire Shelf
(15" version shown)

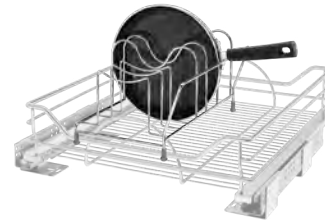

5730-21CR
Pullout Wire Shelf
(21" version shown)

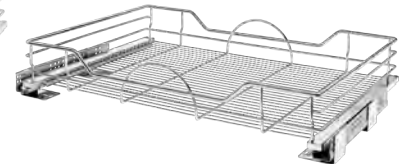

5730-33CR
Pullout Wire Shelf
(33" version shown)

PART	A	B	C	D	E	F
5730-12CR	11-15/16" (303 mm)	11-1/2" (292 mm)	12-5/16" (313 mm)	12-11/16" (322 mm)	13-1/8" (333 mm)	13-7/8" (352 mm)
5730-15CR	14-15/16" (379 mm)	14-1/2" (368 mm)	15-5/16" (389 mm)	15-11/16" (399 mm)	16-1/8" (410 mm)	16-7/8" (429 mm)
5730-21CR	20-15/16" (532 mm)	20-1/2" (521 mm)	21-5/16" (541 mm)	21-11/16" (551 mm)	22-1/8" (562 mm)	22-7/8" (581 mm)
5730-33CR	32-15/16" (837 mm)	32-1/2" (826 mm)	33-5/16" (846 mm)	33-11/16" (856 mm)	34-1/8" (867 mm)	34-7/8" (886 mm)

Pullout Wire Shelf w/ Ball-Bearing Soft-Close

PRODUCT	DESCRIPTION	DIMS	MCO	CAB	FINISH	SLP
5730-12CR	Pullout Wire Shelf	11-11/16" (297 mm) W x 21-3/4" (551 mm) D x 5-5/8" (142 mm) H	11-1/2" (292 mm)	B15	Chrome	\$219.25
5730-15CR	Pullout Wire Shelf	14-11/16" (373 mm) W x 21-3/4" (551 mm) D x 5-5/8" (142 mm) H	14-1/2" (368 mm)	B18	Chrome	\$229.55
5730-21CR	Pullout Wire Shelf	20-11/16" (525 mm) W x 21-3/4" (551 mm) D x 5-5/8" (142 mm) H	20-1/2" (521 mm)	B24	Chrome	\$253.30
5730-33CR	Pullout Wire Shelf	32-11/16" (830 mm) W x 21-3/4" (551 mm) D x 5-5/8" (142 mm) H	32-1/2" (826 mm)	B36	Chrome	\$278.40

Accessories

5789CR	Drop In Cookware Organizer	14-1/16" (357 mm) W x 9-1/2" (241 mm) D x 7-11/16" (195 mm) H			Chrome	\$39.45
--------	----------------------------	---	--	--	--------	---------



5330-33BCSC-MP

- Designed 15", 18", 24", and 36" base cabinets
- Solid bottom shelves with chrome-plated wire, gray or natural maple, or orion gray flat wire with satin solid bottom
- Full-extension slides with BLUMOTION soft-close
- Side and bottom mounting brackets
- Door mounting brackets included (US Patent No. 6,390,576)
- TSCA Title VI compliant



Designed in
cooperation with

Sige
ACCESSORI IN FILLO METALLICO - WIRE PRODUCTS



For video visit:
rev-a-shelf.com/videos

MOUNTING BRACKET OPTIONS

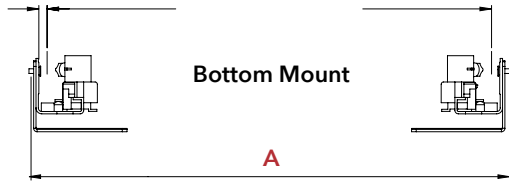

Bottom Mount

A

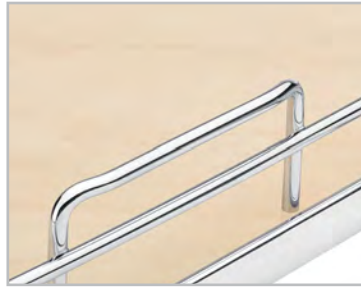

Solid bottom shelves in maple or gray, with chrome accents or orion gray with flat wire



Side Mount
No Spacers

B

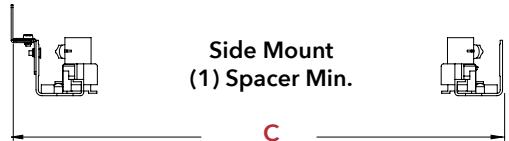

Side Mount
(1) Spacer Min.

C

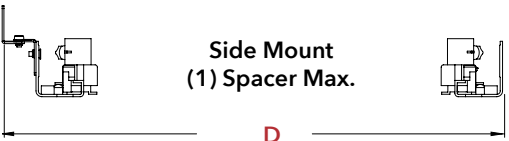

Side Mount
(1) Spacer Max.

D



5330-12BCSC-GR
Solid Bottom Shelf
(12" version shown)



5330-15BCSC-MP
Solid Bottom Shelf
(15" version shown)

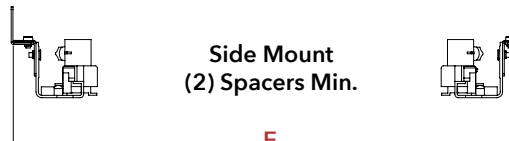

Side Mount
(2) Spacers Min.

E



5330-21BCSC-MP
Solid Bottom Shelf
(21" version shown)



5330-33BCSCFL-FOG
Solid Bottom Shelf
(33" version shown)

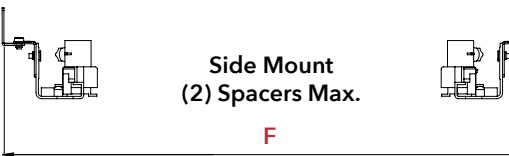

Side Mount
(2) Spacers Max.

F

NOTE: ** Insert "MP" for Maple Shelf or "GR" for Gray Shelf

PART	A	B	C	D	E	F
5330-12BCSC-**	11-15/16" (303 mm)	11-1/2" (292 mm)	12-5/16" (313 mm)	12-11/16" (322 mm)	13-1/8" (333 mm)	13-7/8" (352 mm)
5330-15BCSC-**	14-15/16" (379 mm)	14-1/2" (368 mm)	15-5/16" (389 mm)	15-11/16" (399 mm)	16-1/8" (410 mm)	16-7/8" (429 mm)
5330-21BCSC-**	20-15/16" (532 mm)	20-1/2" (521 mm)	21-5/16" (541 mm)	21-11/16" (551 mm)	22-1/8" (562 mm)	22-7/8" (581 mm)
5330-33BCSC-**	32-15/16" (837 mm)	32-1/2" (826 mm)	33-5/16" (846 mm)	33-11/16" (856 mm)	34-1/8" (867 mm)	34-7/8" (886 mm)
5330-33BCSCFL-FOG	32-15/16" (837 mm)	32-1/2" (826 mm)	33-5/16" (846 mm)	33-11/16" (856 mm)	34-1/8" (867 mm)	34-7/8" (886 mm)

Face Frame Solid Bottom Pullout Shelf w/ BLUMOTION Soft-Close

PRODUCT	DESCRIPTION	DIMS	MCO	CAB	FINISH	SLP
5330-12BCSC-**	Solid Bottom Shelf	11-11/16" (297 mm) W x 21-3/4" (551 mm) D x 5-5/8" (142 mm) H	11-1/2" (292 mm)	FFB15	Chrome	\$392.35
5330-15BCSC-**	Solid Bottom Shelf	14-11/16" (373 mm) W x 21-3/4" (551 mm) D x 5-5/8" (142 mm) H	14-1/2" (368 mm)	FFB18	Chrome	\$400.05
5330-21BCSC-**	Solid Bottom Shelf	20-11/16" (525 mm) W x 21-3/4" (551 mm) D x 5-5/8" (142 mm) H	20-1/2" (521 mm)	FFB24	Chrome	\$426.60
5330-33BCSC-**	Solid Bottom Shelf	32-11/16" (830 mm) W x 21-3/4" (551 mm) D x 5-5/8" (142 mm) H	32-1/2" (826 mm)	FFB36	Chrome	\$452.55

Full Access Solid Bottom Pullout Shelf w/ BLUMOTION Soft-Close

5330-33BCSCFL-FOG	Solid Bottom Shelf	32-11/16" (830 mm) W x 21-3/4" (551 mm) D x 5-3/4" (146 mm) H	32-1/2" (826 mm)	FLB36	Orion Gray	\$477.75
-------------------	--------------------	---	------------------	-------	------------	----------



ML-WNHDSCOF-18FL

RAS-ML Series

- Fits most cabinet sizes
- Works with your custom shelf
- Mounts to cabinet side
- Adjustable spring tension
- Available with built-in shock dampeners
- Holds appliances up to 60 lbs.

ML Series

- Silver lift:
 - Designed for 18" face frame base cabinets
 - 1-1/2" thick maple shelf
- Orion gray lift:
 - Designed for 18" full access base cabinets
 - 1-1/2" thick walnut shelf
- Mounts to cabinet side
- Adjustable spring tension
- Built-in shock dampeners
- Holds appliances up to 60 lbs.
- TSCA Title VI compliant



For video visit:
rev-a-shelf.com/videos

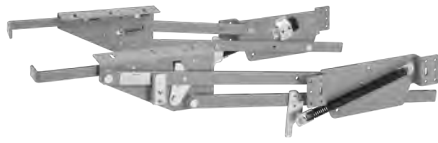

RAS-ML-HDCR
Mixer Lift
(Chrome finish Shown)

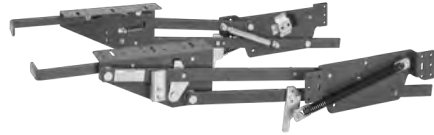

RAS-ML-HDSCOG
Soft-Close Mixer Lift
(Orion Gray finish shown)

RECOMMENDED SPRING POSITION FOR VARYING MIXER WEIGHT

- 0-20 lb. = 1
- 20-30 lb. = 2
- 30-60 lb. = 3



Soft-Close piston



Great for a variety of small appliances

Pase Solutions

SOFT-CLOSE MIXER LIFT KITS W/ SHELF INCLUDED MIXER CLEARING DIMENSIONS

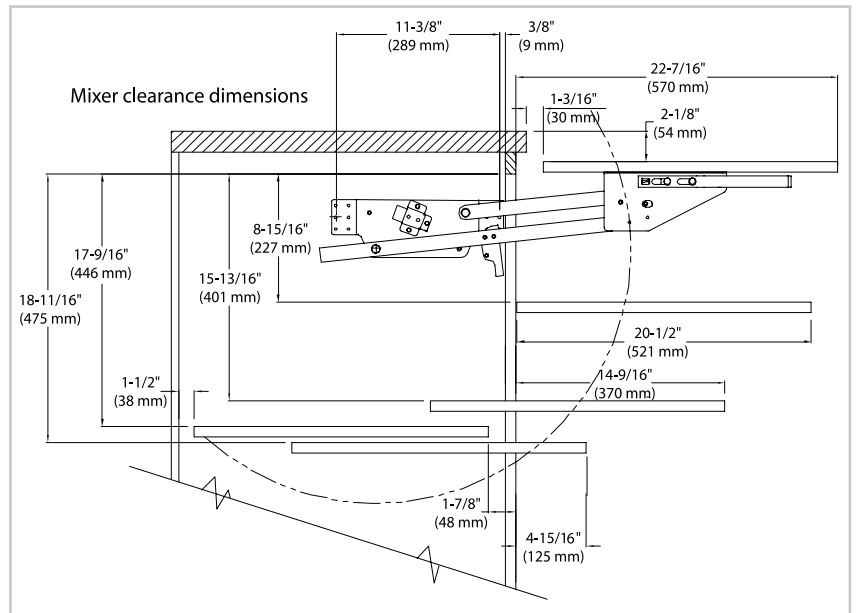

NOTE: To determine shelf size measure the distance between mounting plates when installed minus 1-1/4" (32 mm). Recommended length of shelf is 20" (508 mm). Mounting plates are 1" wide.

Heavy Duty Mixer Lift Kit w/ Soft-Close

PRODUCT	DESCRIPTION	DIMS	MCO	CAB	FINISH	SLP
ML-MPHDSCCR-18	Mixer Lift Kit	See Illustration	15" (381 mm)	FFFHB18	Silver/ Maple	\$406.05
ML-WNHDS COG-18FL	Mixer Lift Kit	See Illustration	16-1/2" (419 mm)	FLFHB18	Orion Gray	\$543.65

Heavy Duty Mixer Lift w/ Soft- Close - Arms Only

RAS-ML-HDSCOG	Mixer Lift	See Illustration			Orion Gray	\$296.45
RAS-ML-HDSC	Mixer Lift	See Illustration			Silver	\$291.65

Heavy Duty Mixer Lift

RAS-ML-HDCR	Mixer Lift	See Illustration			Silver	\$168.20
-------------	------------	------------------	--	--	--------	----------